



PowerQ4 Plus
MI 2792A
Instruction manual
Version 1.0, Code No. 20 752 082

Distributor:

Manufacturer:

METREL d.d.
Ljubljanska cesta 77
1354 Horjul
Slovenia

web site: <http://www.metrel.si>
e-mail: metrel@metrel.si



Mark on your equipment certifies that this equipment meets the requirements of the EU (European Union) concerning safety and interference causing equipment regulations

© 2012 METREL

No part of this publication may be reproduced or utilized in any form or by any means without permission in writing from METREL.

1	Introduction.....	6
1.1	Main Features	6
1.2	Safety considerations	7
1.3	Applicable standards	8
1.4	Abbreviations.....	8
2	Description.....	12
2.1	Front panel	12
2.2	Connector panel	13
2.3	Bottom view.....	14
2.4	Accessories.....	14
2.4.1	Standard accessories.....	14
2.4.2	Optional accessories	15
3	Operating the instrument.....	16
3.1	Instrument Main Menu.....	17
3.1.1	Instrument main functions	18
3.2	U, I, f menu.....	19
3.2.1	Meter.....	19
3.2.2	Scope.....	20
3.2.3	Trend.....	22
3.3	Power menu	25
3.3.1	Meter.....	25
3.3.2	Trend.....	26
3.4	Energy menu.....	28
3.5	Harmonics / interharmonics menu.....	29
3.5.1	Meter.....	29
3.5.2	Histogram (Bar).....	31
3.5.3	Trend.....	32
3.6	Flickermeter.....	35
3.6.1	Meter.....	35
3.6.2	Trend.....	36
3.7	Phase Diagram.....	37
3.7.1	Phase diagram	37
3.7.2	Symmetry diagram	38
3.7.3	Symmetry trend.....	39
3.8	Temperature.....	41
3.8.1	Meter.....	41
3.8.2	Trend.....	41
3.9	General Recorder.....	42
3.10	Waveform recorder.....	45
3.10.1	Setup.....	45
3.10.2	Capturing waveform	47
3.10.3	Captured waveform.....	48
3.11	Inrush / Fast recorder	51
3.11.1	Setup.....	52
3.11.2	Capturing inrush.....	53
3.11.3	Captured inrush.....	54
3.12	Transients recorder	56
3.12.1	Setup.....	56
3.12.2	Capturing transients	57
3.12.3	Captured transients.....	58

3.13	Events table.....	61
3.14	Alarms table	65
3.15	Memory List.....	66
3.15.1	Record.....	68
3.15.2	Waveform snapshot	70
3.15.3	Waveform record.....	71
3.15.4	Inrush/Fast logger	71
3.15.5	Transients record	71
3.16	Measurement Setup menu	71
3.16.1	Connection setup	72
3.16.2	Event setup	74
3.16.3	Alarm setup	74
3.16.4	Signalling setup.....	76
3.17	General Setup menu	76
3.17.1	Communication	77
3.17.2	Time & Date	79
3.17.3	Language	79
3.17.4	Clear Memory.....	80
3.17.5	Instrument info	81
3.17.6	Lock/Unlock.....	81
4	Recording Practice and Instrument Connection	83
4.1	Measurement campaign.....	83
4.2	Connection setup	87
4.2.1	Connection to the LV Power Systems.....	87
4.2.2	Connection to the MV or HV Power System.....	91
4.2.3	Current clamp selection and transformation ratio setting	92
4.2.4	Temperature probe connection	96
4.2.5	GPS time synchronization device connection	97
4.2.6	GPRS modem connection.....	98
4.3	Number of measured parameters and connection type relationship	99
5	Theory and internal operation	102
5.1	Measurement methods.....	102
5.1.1	Measurement aggregation over time intervals	102
5.1.2	Voltage measurement (magnitude of supply voltage)	102
5.1.3	Current measurement (magnitude of supply current).....	103
5.1.4	Frequency measurement	103
5.1.5	Phase power measurements.....	104
5.1.6	Total power measurements.....	104
5.1.7	Energy.....	105
5.1.8	Harmonics and interharmonics.....	106
5.1.9	Signalling.....	107
5.1.10	Flicker.....	108
5.1.11	Voltage and current unbalance	109
5.1.12	Voltage events	110
5.1.13	Alarms	112
5.1.14	Data aggregation in GENERAL RECORDING	113
5.1.15	Waveform snapshot	117
5.1.16	Waveform record.....	117
5.1.17	Transient recorder.....	118
5.1.18	Inrush/Fast recorder.....	118

5.2	EN 50160 Standard Overview	120
5.2.1	Power frequency	120
5.2.2	Supply voltage variations	121
5.2.3	Voltage dips (Indicative values).....	121
5.2.4	Short interruptions of the supply voltage	121
5.2.5	Long interruptions of the supply voltage.....	121
5.2.6	Supply voltage unbalance	121
5.2.7	THD voltage and harmonics.....	121
5.2.8	Interharmonic voltage.....	122
5.2.9	Mains signalling on the supply voltage.....	122
5.2.10	Flicker severity	122
5.2.11	PowerQ4 / PowerQ4 Plus recorder setting for EN 50160 survey	122
6	Technical specifications	124
6.1	General specifications	124
6.2	Measurements.....	124
6.2.1	General description	124
6.2.2	Phase Voltages	125
6.2.3	Line voltages	126
6.2.4	Current	126
6.2.5	Frequency	127
6.2.6	Flickermeter	127
6.2.7	Power	128
6.2.8	Power factor (Pf)	128
6.2.9	Displacement factor (Cos ϕ).....	128
6.2.10	Energy.....	128
6.2.11	Voltage harmonics and THD	129
6.2.12	Current harmonics and THD	129
6.2.13	Voltage interharmonics.....	130
6.2.14	Current interharmonics.....	130
6.2.15	Signalling.....	130
6.2.16	Unbalance	130
6.2.17	Time and duration uncertainty.....	130
6.2.18	Temperature.....	131
6.3	Recorders.....	132
6.3.1	General recorder	132
6.3.2	Waveform recorder.....	132
6.3.3	Inrush/fast recorder	132
6.3.4	Waveform snapshot	133
6.3.5	Transients recorder	133
6.4	Standards compliance.....	133
6.4.1	Compliance to the IEC 61557-12	134
6.4.2	Compliance to the to the IEC 61000-4-30	133
7	Maintenance.....	134
7.1	Inserting batteries into the instrument	134
7.2	Batteries	136
7.3	Power supply considerations.....	136
7.4	Cleaning	137
7.5	Periodic calibration	137
7.6	Service	137
7.7	Troubleshooting.....	137

1 Introduction

PowerQ4 Plus is handheld multifunction instruments for power quality analysis and energy efficiency measurements.

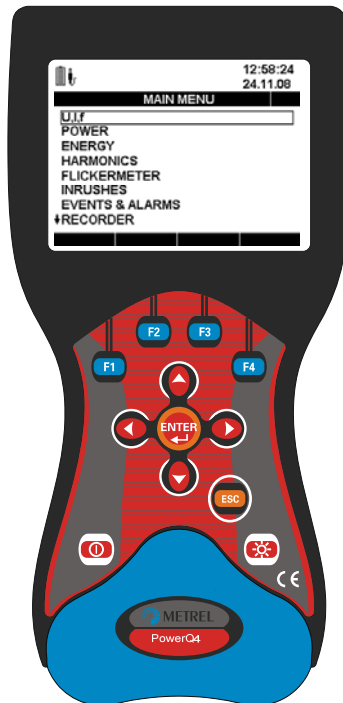

Figure 1.1: Instrument PowerQ4 Plus

1.1 Main Features

- 4 voltage channels with wide measurement range: 0 ÷ 1000 Vrms, CAT III / 1000 V.
- 4 current channels with support for automatic clamp recognition and “on instrument” range selection¹.
- Compliance with power quality standard IEC 61000-4-30 Class A/S. Predefined recorder profile for EN 50160 survey.
- Power measurements compliance with IEC 61557-12 and IEEE 1448.
- Simultaneous 8 channels - 16bit AD conversion for accurate power measurements (minimal phase shift error).
- Simple to use and powerful recorder with 8 MB of memory and possibility to record 524 different power quality signatures.
- Interharmonics and mains signalling measuring and recording.

¹ only with Metrel »Smart clamps«

- Digital thermometer for temperature measurement.
- Powerful troubleshooting tools: transient^{Error! Bookmark not defined.}, inrush/fast, and waveform recorder.
- Voltage events and user defined alarms capture.
- 15 hour of autonomous (battery) supply.
- **PowerView v2.0** is a companion PC Software which provides easiest way to download, view and analyze measured data or print.
 - PowerView v2.0 analyzer exposes a simple but powerful interface for downloading instrument data and getting quick, intuitive and descriptive analysis. Interface has been organized to allow quick selection of data using a Windows Explorer-like tree view.
 - User can easily download recorded data, and organize it into multiple sites with many sub-sites or locations.
 - Generate charts, tables and graphs for your power quality data analyzing, and create professional printed reports.
 - Export or copy / paste data to other applications (e.g. spreadsheet) for further analysis.
 - Multiple data records can be displayed and analyzed simultaneously. Merge different logging data into one measurement, synchronize data recorded with different instruments with time offsets, split logging data into multiple measurements, or extract data of interest.

1.2 Safety considerations

To ensure operator safety while using the PowerQ4 Plus instrument and to minimize the risk of damage to the instrument, please note the following general warnings:



The instrument has been designed to ensure maximum operator safety. Usage in a way other than specified in this manual may increase the risk of harm to the operator!



Do not use the instrument and/or any accessories if there is any damage visible!



The instrument contains no user serviceable parts. Only an authorized dealer can carry out service or adjustment!



All normal safety precautions have to be taken in order to avoid risk of electric shock when working on electrical installations!





Only use approved accessories which are available from your distributor!



Instrument contains rechargeable NiMh batteries. The batteries should only be replaced with the same type as defined on the battery placement label or in this manual. Do not use standard batteries while power supply adapter/charger is connected, otherwise they may explode!



Hazardous voltages exist inside the instrument. Disconnect all test leads, remove the power supply cable and switch off the instrument before removing battery compartment cover.

-  In hot (> 40 °C) environment the battery holder screw might reach maximum allowed temperature for metal part of handle. In such environment it is advisable not to touch the battery cover during or immediately after the charging.
-  Maximum voltage between any phase and neutral input is 1000 V_{RMS}. Maximum voltage between phases is 1730 V_{RMS}.
-  Always short unused voltage inputs (L1, L2, L3, GND) with neutral (N) input to prevent measurement errors and false event triggering due to noise coupling.

1.3 Applicable standards

The PowerQ4 Plus is designed and tested in accordance with the following standards:

Electromagnetic compatibility(EMC)

EN 61326-2-2: 2006	Electrical equipment for measurement, control and laboratory use. <ul style="list-style-type: none"> • Emission: Class A equipment (for industrial purposes) • Immunity for equipment intended for use in industrial locations
--------------------	--

Safety (LVD)

EN 61010-1: 2001	Safety requirements for electrical equipment for measurement, control and laboratory use
------------------	--

Measurements methods

IEC 61000-4-30: 2008	Testing and measurement techniques – Power quality measurement methods
IEC 61557-12: 2007	Equipment for testing, measuring or monitoring of protective measures – Part 12: Performance measuring and monitoring devices (PMD)
IEC 61000-4-7: 2002 + A1: 2008 Class I	General guide on harmonics and interharmonics measurements and instrumentation
IEC 61000-4-15 : 2010	Flickermeter – Functional and design specifications
EN 50160 : 2010	Voltage characteristics of electricity supplied by public distribution networks

Note about EN and IEC standards:

Text of this manual contains references to European standards. All standards of EN 6XXXX (e.g. EN 61010) series are equivalent to IEC standards with the same number (e.g. IEC 61010) and differ only in amended parts required by European harmonization procedure.

1.4 Abbreviations

In this document following symbols and abbreviations are used:

Cf_I	Current crest factor, including Cf_{Ip} (phase p current crest factor) and Cf_{IN} (neutral current crest factor). See 5.1.3 for definition.
Cf_U	Voltage crest factor, including Cf_{Upq} (phase p to phase q voltage crest

	factor) and Cf_{Up} (phase p to neutral voltage crest factor). See 5.1.2 for definition.
$\text{Cos}\varphi$, DPF	Displacement factor including $\text{Cos}\varphi_p$ / DPF_p (phase p displacement factor). See 5.1.5 and 5.1.6 for definition.
eP^+ , eP^-	Active energy including eP_p (phase p energy) and eP_{tot} (total energy). Minus sign indicates generated energy and plus sign, indicate consumed energy. See 5.1.7 for definition.
eQ^{i+} , eQ^{c+} , eQ^{i-} , eQ^{c-}	Reactive energy including eQ_p (phase p energy) and eQ_{tot} (total energy). Minus sign indicates generated energy and plus sign, indicate consumed energy. Inductive reactive energy character is marked with "i" and capacitive reactive energy character is marked with "c". See 5.1.7 for definition.
eS^+ , eS^-	Apparent energy. Minus sign indicates generated energy and plus sign, indicate consumed energy. See 5.1.7 for definition.
f , freq	Frequency, including $\text{freq}_{U_{12}}$ (voltage frequency on U_{12}), freq_{U_1} (voltage frequency on U_1) and freq_{I_1} (current frequency on I_1). See 5.1.4 for definition.
\bar{i}	Negative sequence current ratio (%). See 5.1.11 for definition.
i^0	Zero sequence current ratio (%). See 5.1.11 for definition.
I^+	Positive sequence current component on three phase systems. See 5.1.11 for definition.
I^-	Negative sequence current component on three phase systems. See 5.1.11 for definition.
i^0	Zero sequence current components on three phase systems. See 5.1.11 for definition.
$I_{\frac{1}{2}\text{Rms}}$	RMS current measured over each half period, including $I_{p\frac{1}{2}\text{Rms}}$ (phase p current), $I_{N\frac{1}{2}\text{Rms}}$ (neutral RMS current)
I_{Fnd}	Fundamental RMS current I_{h_1} (on 1 st harmonics), including $I_{p\text{Fnd}}$ (phase p fundamental RMS current) and $I_{N\text{Fnd}}$ (neutral RMS fundamental current). See 5.1.8 for definition
I_{h_n}	n^{th} current RMS harmonic component including I_{ph_n} (phase p; n^{th} RMS current harmonic component) and I_{Nh_n} (neutral n^{th} RMS current harmonic component). See 5.1.8 for definition
I_{ih_n}	n^{th} current RMS interharmonic component including $I_{p\text{ih}_n}$ (phase p; n^{th} RMS current interharmonic component) and $I_{N\text{ih}_n}$ (neutral n^{th} RMS current interharmonic component). See 5.1.8 for definition
I_{Nom}	Nominal current. Current of clamp-on current sensor for 1 V _{rms} at output
I_{Pk}	Peak current, including $I_{p\text{Pk}}$ (phase p current) including $I_{N\text{Pk}}$ (neutral peak current)
I_{Rms}	RMS current, including $I_{p\text{Rms}}$ (phase p current), $I_{N\text{Rms}}$ (neutral RMS current). See 5.1.3 for definition.
$\pm P$, P^+ , P^-	Active power including P_p (phase p active power) and P_{tot} (total active power). Minus sign indicates generated power and plus / no sign, indicate

	consumed power. See 5.1.5 and 5.1.6 for definition.
p, pg	Indices. Annotation for parameter on phase p: [1, 2, 3] or phase-to-phase pg: [12, 23, 31]
$PF, PF^+, PF^{c+}, PF^i, PF^{c-}$	Power factor including PF_p (phase p power factor vector) and PF_{tot} (total power factor vector). Minus sign indicates generated power and plus sign, indicate consumed power. Inductive power factor character is marked with “i” and capacitive power factor character is marked with “c”. Note: $PF = \text{Cos } \varphi$ when upper harmonics are not present. See 5.1.5 and 5.1.6 for definition.
P_{lt}	Long term flicker (2 hours) including P_{ltpg} (phase p to phase g long term voltage flicker) and P_{ltp} (phase p to neutral long term voltage flicker). See 5.1.9 for definition.
P_{st}	Short term flicker (10 minutes) including P_{stpg} (phase p to phase g short term voltage flicker) and P_{stp} (phase p to neutral voltage flicker). See 5.1.9 for definition.
P_{st1min}	Short term flicker (1 minutes) including $P_{st1minpg}$ (phase p to phase g short term voltage flicker) and $P_{st1minp}$ (phase p to neutral voltage flicker). See 5.1.9 for definition.
$\pm Q, Q^{c+}, Q^{c-}, Q^+, Q^i, Q^c$	Reactive power including Q_p (phase p reactive power) and Q_{tot} (total reactive power). Minus sign indicates generated power and plus sign, indicate consumed power. Inductive reactive character is marked with “i” and capacitive reactive character is marked with “c”. See 5.1.5 and 5.1.6 for definition.
S, S^+, S^-	Apparent power including S_p (phase p apparent power) and S_{tot} (total apparent power). See 5.1.5 and 5.1.6 for definition. Minus sign indicates apparent power during generation and plus sign indicate apparent power during consumption. See 5.1.5 and 5.1.6 for definition.
THD_I	Total harmonic distortion current related to fundamental, including THD_{Ip} (phase p current THD) and THD_{IN} (neutral current THD). See 5.1.8 for definition
THD_U	total harmonic distortion voltage related to fundamental, including THD_{Upg} (phase p to phase g voltage THD) and THD_{Up} (phase p to neutral voltage THD). See 5.1.11 for definition.
u^-	Negative sequence voltage ratio (%). See 5.1.11 for definition.
u^0	Zero sequence voltage ratio (%). See 5.1.11 for definition.
U, U_{Rms}	RMS voltage, including U_{pg} (phase p to phase g voltage) and U_p (phase p to neutral voltage). See 5.1.2 for definition.
U^+	Positive sequence voltage component on three phase systems. See 5.1.11 for definition.
U^-	Negative sequence voltage component on three phase systems. See 5.1.11 for definition.
U^0	Zero sequence voltage component on three phase systems. See 5.1.11 for definition.

U_{Dip}	Minimal $U_{Rms(1/2)}$ voltage measured during dip occurrence
U_{Fnd}	Fundamental RMS voltage (U_{h_1} on 1 st harmonics), including U_{pgFnd} (phase p to phase g fundamental RMS voltage) and U_{pFnd} (phase p to neutral fundamental RMS voltage). See 5.1.8 for definition
U_{h_N}	n^{th} voltage RMS harmonic component including U_{pgh_N} (phase p to phase g voltage n^{th} RMS harmonic component) and U_{ph_N} (phase p to neutral voltage n^{th} RMS harmonic component). See 5.1.8 for definition.
U_{ih_N}	n^{th} voltage RMS interharmonic component including U_{pgih_N} (phase p to phase g voltage n^{th} RMS interharmonic component) and U_{pih_N} (phase p to neutral voltage n^{th} RMS interharmonic component). See 5.1.8 for definition.
U_{Int}	Minimal $U_{Rms(1/2)}$ voltage measured during interrupt occurrence
U_{Nom}	Nominal voltage, normally a voltage by which network is designated or identified
U_{Pk}	Peak voltage, including U_{pgPk} (phase p to phase g voltage) and U_{pPk} (phase p to neutral voltage)
$U_{Rms(1/2)}$	RMS voltage refreshed each half-cycle, including $U_{pgRms(1/2)}$ (phase p to phase g half-cycle voltage) and $U_{pRms(1/2)}$ (phase p to neutral half-cycle voltage) See 5.1.12 for definition.
U_{Swell}	Maximal $U_{Rms(1/2)}$ voltage measured during swell occurrence
U_{Sig}	Mains signalling RMS voltage. Signalling is a burst of signals, often applied at a non-harmonic frequency, that remotely control equipment. See 5.2.9 for details

2 Description

2.1 Front panel

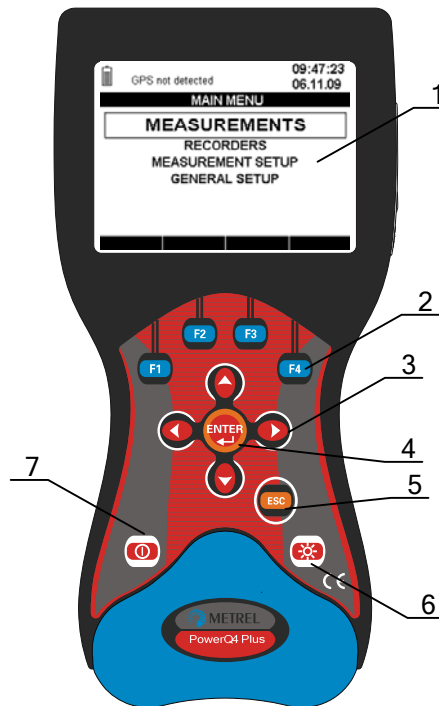
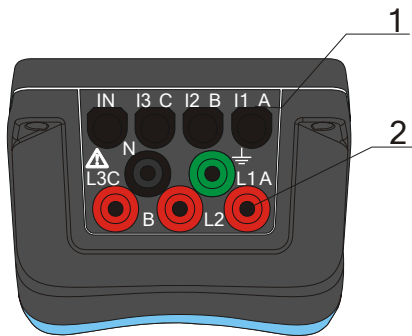

Figure 2.1: Front panel

Front panel layout:

- | | |
|----------------------|---|
| 1. LCD | Graphic display with LED backlight, 320 x 200 pixels. |
| 2. F1 – F4 | Function keys. |
| 3. ARROW keys | Move cursor and select parameters. |
| 4. ENTER key | Confirms new settings, step into submenu. |
| 5. ESC key | Exits any procedure, exit from submenu. |
| 6. LIGHT key | LCD backlight on/off (backlight automatically turns off after 15 minutes if no key action occurs).
If the <i>LIGHT</i> key is pressed for more than 1.5 seconds, <i>CONTRAST</i> menu is displayed. Contrast can be adjusted with the <i>LEFT</i> and <i>RIGHT</i> keys. |
| 7. ON-OFF key | Turns on/off the instrument. |

2.2 Connector panel



Warning!

- Use safety test leads only!
- Max. permissible voltage between voltage input terminals and ground is 1000 V_{RMS} !

Figure 2.2: Top connector panel

Top connector panel layout:

- 1 Clamp-on current transformers (I_1 , I_2 , I_3 , I_N) input terminals.
- 2 Voltage (L_1 , L_2 , L_3 , N, GND) input terminals.

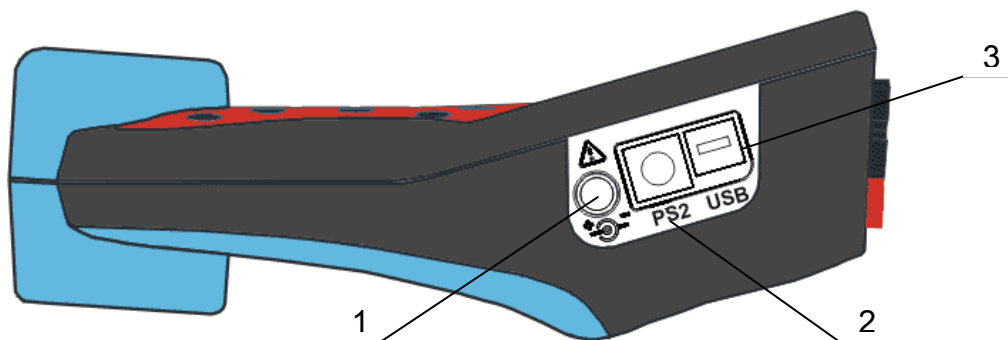

Figure 2.3: Side connector panel

Side connector panel layout:

- 1 External power socket.
- 2 PS-2 – RS-232/GPS serial connector.
- 3 USB/GPRS – Connector.

2.3 Bottom view

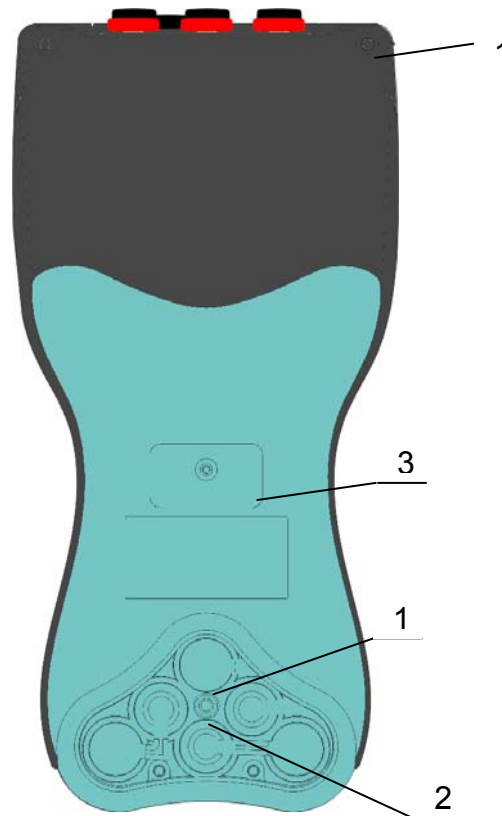

Figure 2.4: Bottom view

Bottom view layout:

1. Battery compartment.
2. Battery compartment screw (unscrew to replace the batteries).
3. Serial number label.

2.4 Accessories

2.4.1 Standard accessories











Table 2.1: PowerQ4 Plus standard accessories

Description	Peaces
Flexible current clamp 3000 A / 300 A / 30 A (A 1227)	4
Temperature probe (A 1354)	1
Test probe, red	2
Test probe (CAT II), red	3
Test probe (CAT II), black	1
Crocodile clip, red	3
Crocodile clip, black	1
Crocodile clip, green	1
Voltage measurement cable, red	3

Voltage measurement cable, black	1
Voltage measurement cable, green	1
USB cable	1
GPS Receiver	1
RS232 cable	1
12 V / 1.2 A Power supply adapter	1
NiMH rechargeable battery, type HR 6 (AA)	6
Soft carrying bag	1
Instruction manual	1
Compact disk contest – related to PowerQ4 Plus	
<ul style="list-style-type: none"> PC software PowerView v2.0 with instruction manual 	
<ul style="list-style-type: none"> Instruction manual 	
<ul style="list-style-type: none"> Handbook "Modern Power Quality Measurement Techniques" 	

2.4.2 Optional accessories

Table 2.2: PowerQ4 Plus optional accessories

Ord. code	Description	
A 1020	Small soft carrying bag	
A 1033	Current clamp 1000 A / 1 V	
A 1037	Current transformer 5 A / 1 V	
A 1039	Connection cable for current clamp	
A 1069	Mini current clamp 100 A / 1 V	
A 1122	Mini current clamp 5 A / 1 V	
A 1179	3-phase flexible current clamps 2000 A / 200 A / 20 A	
S 2014	Safety fuse adapters	
S 2015	Safety flat clamps	
A 1281	Current clamp 5 A / 100 A / 1000 A	
A 1356	GPRS Modem	

3 Operating the instrument

This section describes how to operate the instrument. The instrument front panel consists of a graphic LCD display and keypad. Measured data and instrument status are shown on the display. Basic display symbols and keys description is shown on figure bellow.

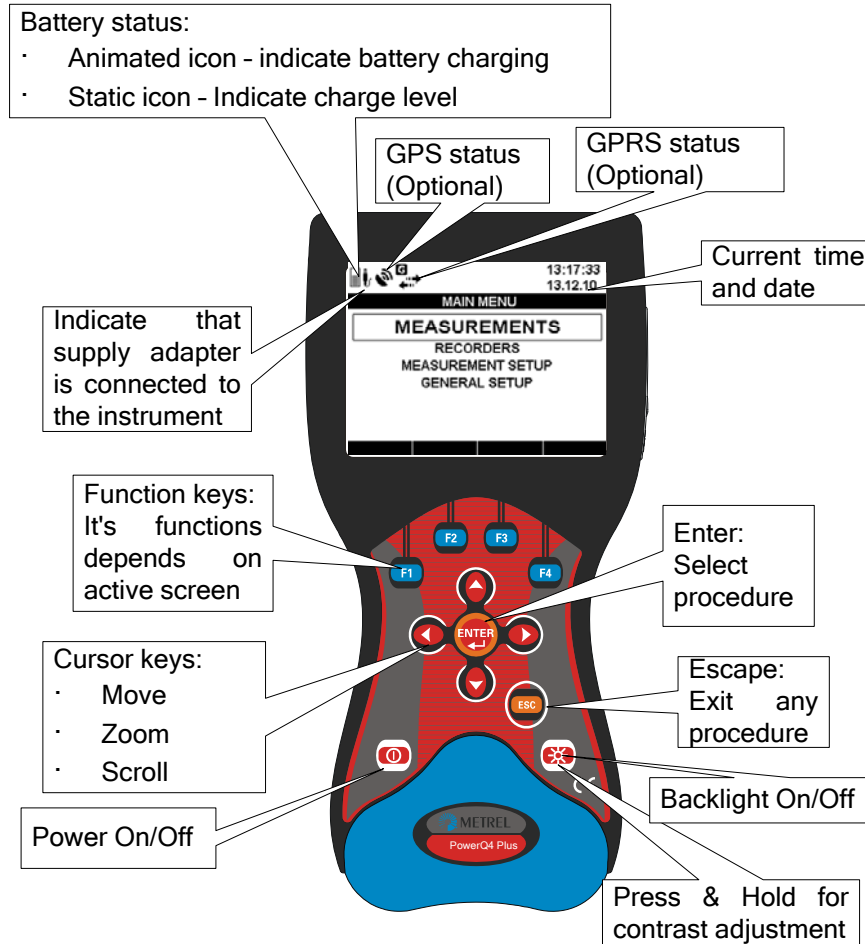

Figure 3.1: Display symbols and keys description

During measurement campaign various screens can be displayed. Most screens share common labels and symbols. These are shown on figure bellow.

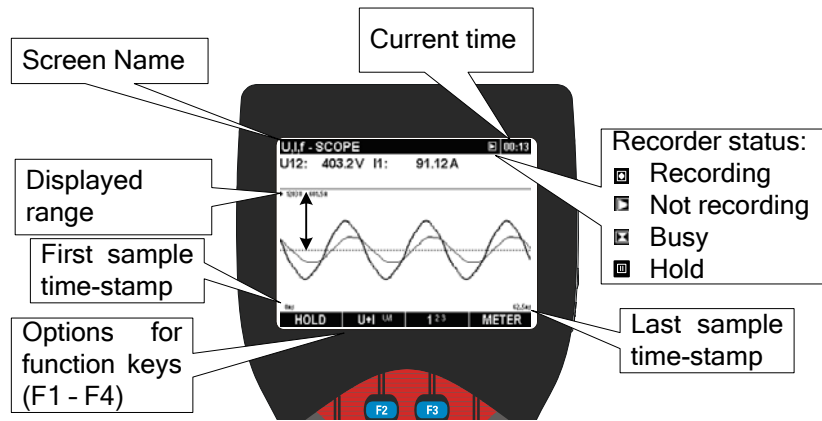

Figure 3.2: Common display symbols and labels during measurement campaign

3.1 Instrument Main Menu

After powering on the instrument the “MAIN MENU” is displayed. From this menu all instrument functions can be selected.

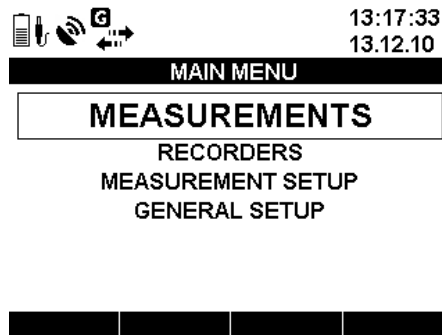

Figure 3.3: “MAIN MENU”

Table 3.1: Instrument screen symbols and abbreviations

	<p>Battery status</p> <ul style="list-style-type: none"> • Animated icon – indicate battery charging • Static icon – Indicate charge level
	<p>Indicate that charger is connected to the instrument</p>
	<p>GPS module status (Optional accessory A 1355)</p>
	<p>GPS module detected but reporting invalid time and position data (searching for satellites or too weak satellite signal)</p>
	<p>GPS time valid – valid satellite GPS time signal)</p>
	<p>GPRS modem status (Optional accessory A 1356)</p>
	<p>GPRS is in initialization mode (see section 4.2.6 for details)</p>





	GPRS modem is ready to receive user call (see section 4.2.6 for details)
	GPRS communication is in progress (see section 4.2.6 for details)
12:58:24 24.11.08	Current time and date

Table 3.2: Keys functions

	Select function from the “MAIN MENU”.
	Enter selected function.

3.1.1 Instrument main functions

By pressing ENTER function, user can select one of four menu subgroup of function:

- Measurements – set of basic measurement screens,
- Recorder – setup and view of various recording,
- Measurement Setup –parameterization of measurement parameters/procedures,
- General Setup – configuring or checking of other instrument parameters.

List of all submenu are presented on following figure.

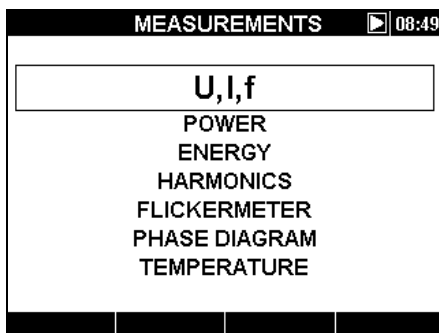

Figure 3.4: Measurements menu

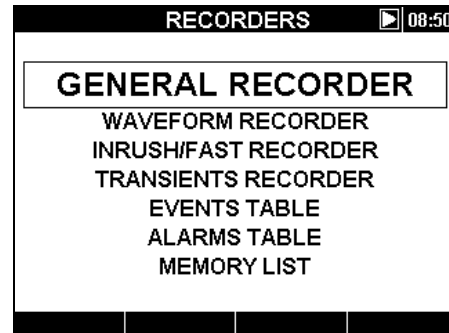

Figure 3.5: Recorders menu

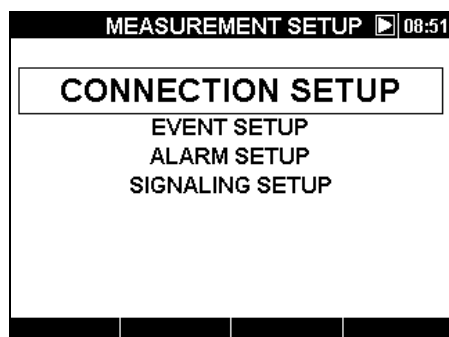

Figure 3.6: Measurement setup menu

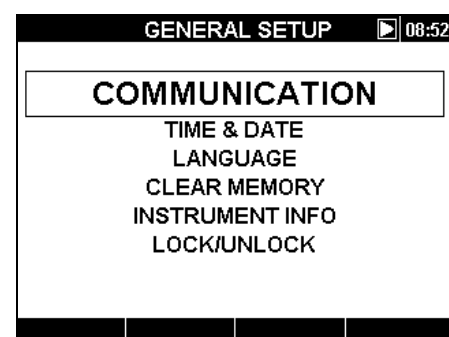

Figure 3.7: General setup menu

3.2 U, I, f menu

All important voltage, current and frequency parameters can be observed in the “U, I, f” menu. Measurements results can be viewed in a tabular (METER) or a graphical form (SCOPE, TREND). TREND view is active only in RECORDING mode. See section 3.9 for details.

3.2.1 Meter

By entering U, I, f menu, the U, I, f – METER tabular screen is shown (see figure below).

U,I,f - METER			L1	00:25
	U	I		
RMS	226.9 V	887.1 A		
THD	3.3 %	3.2 %		
CF	1.37	1.38		
PEAK	379.1 V	1253 A		
MAX 1/2	269.1 V	3919 A		
MIN 1/2	160.2 V	850.3 A		
Freq	49.968 Hz			
HOLD	RESET	1 2 3 N Δ	SCOPE	

U,I,f - METER					Σ	00:22
	L1	L2	L3	Ln		
UL	227.2	228.9	228.6 V		0.3 V	
ThdU	2.8	3.0	2.7 %		---.-%	
IL	888.5	892.7	906.3 A		3.4 A	
ThdI	3.2	4.2	3.1 %		266.6 %	
f:	49.972		Hz			
HOLD	FREQ	1 2 3 N Δ	SCOPE			

Figure 3.8: U, I, f meter table screens

In those screens on-line voltage and current measurements are shown. Descriptions of symbol and abbreviations used in this menu are shown in table below.

Table 3.3: Instrument screen symbols and abbreviations

L1 L2 L3	
L12 L23 L31	Show currently displayed channel.
N Δ	
	Current recorder status
	RECORDER is active
	RECORDER is busy (retrieving data from memory)
	RECORDER is not active
20:45	Current instrument time
RMS	True effective value U_{Rms} and I_{Rms}
THD	Total harmonic distortion THD_U and THD_I
CF	Crest factor Cf_U and Cf_I
PEAK	Peak value U_{Pk} and I_{Pk}
MAX 1/2	Maximal $U_{Rms(1/2)}$ voltage and maximal $I_{1/2Rms}$ current, measured after RESET (key: F2)
MIN 1/2	Minimal $U_{Rms(1/2)}$ voltage and minimal $I_{1/2Rms}$ current, measured after RESET (key: F2)
f	Frequency on reference channel

Note: In case of AD converter overloading current and voltage value will be displayed with inverted color **250.4 V**.

Note: If phase current and voltage value are not within 10% ÷ 150% of the range, their values will be displayed with inverted color **250.4 V**.

Table 3.4: Keys functions

F1	HOLD	Waveform snapshot: Hold measurement on display
	SAVE	Save held measurement into memory
F2	RESET	Reset MAX ½ and MIN ½ values ($U_{Rms(1/2)}$ and $I_{1/2Rms}$)
	f	Show frequency trend (available only during recording)
F3	1 2 3 N Δ	Show measurements for phase L1
	1 2 3 N Δ	Show measurements for phase L2
	1 2 3 N Δ	Show measurements for phase L3
	1 2 3 N Δ	Show measurements for neutral channel
	1 2 3 N Δ	Summary of all phases measurements
	1 2 3 N Δ	Show phase-to-phase voltages measurements
F4	METER	Switch to METER view.
	SCOPE	Switch to SCOPE view
	TREND	Switch to TREND view (available only during recording)
ESC		Return to the “MEASUREMENTS” menu screen.

3.2.2 Scope

Various combinations of voltage and current waveforms are displayed.

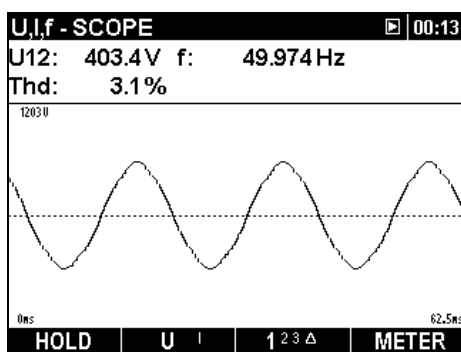

Figure 3.9: Voltage waveform

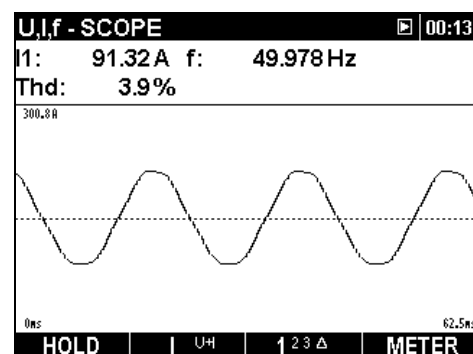

Figure 3.10: Current waveform

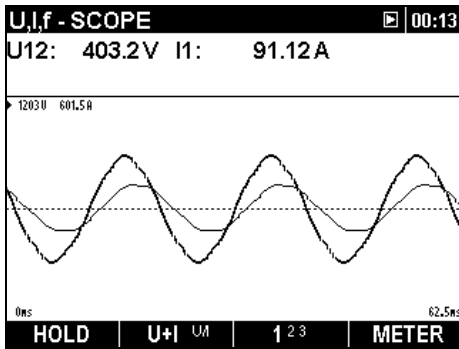

Figure 3.11: Voltage and current waveform (single mode)

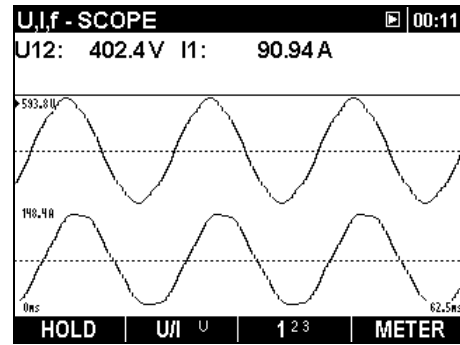

Figure 3.12: Voltage and current waveform (dual mode)

Table 3.5: Instrument screen symbols and abbreviations

	Current recorder status
	RECORDER is active
	RECORDER is busy (retrieving data from memory)
	RECORDER is not active
20:45	Current instrument time
Up p: [1..3, N]	True effective value of phase voltage: U _{1Rms} , U _{2Rms} , U _{3Rms} , U _{NRms}
Up _g p,g: [1, 2, 3]	True effective value of phase-to-phase (line) voltage: U _{12Rms} , U _{23Rms} , U _{31Rms}
Ip p: [1..3, N]	True effective value of current: I _{1Rms} , I _{2Rms} , I _{3Rms} , I _{NRms}
Thd	Total harmonic distortion for displayed quantity (THD _U or THD _I)
f	Frequency on reference channel

Table 3.6: Keys functions

F1	Waveform snapshot:
HOLD	Hold measurement on display
SAVE	Save held measurement into memory
	Select which waveforms to show:
F2	U I Show voltage waveform
	I U+I Show current waveform
	U+I U/I Show voltage and current waveform (single graph)
	U/I U Show voltage and current waveform (dual graph)
F3	Select between phase, neutral, all-phases and line view:
	1 2 3 N A Show waveforms for phase L1

	Show waveforms for phase L2
	Show waveforms for phase L3
	Show waveforms for neutral channel
	Summary of all phases waveforms
	METER Switch to METER view
	SCOPE Switch to SCOPE view
	TREND Switch to TREND view (available only during recording)
	Select which waveform to zoom (only in U/I or U+I)
	Set vertical zoom
	Set horizontal zoom
	Exit from "HOLD" screen without saving. Return to the "MEASUREMENTS" menu screen.

3.2.3 Trend

While RECORDER is active, TREND view is available (see section 3.9 for instructions how to start recorder).

Voltage and current trends

Current and voltage trends can be observed by cycling function key F4 (METER-SCOPE-TREND).

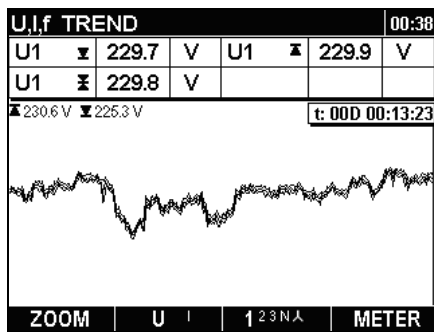

Figure 3.13: Voltage trend

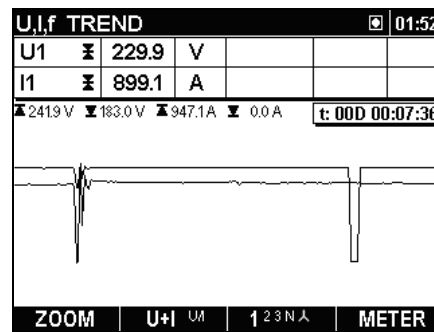

Figure 3.14: Voltage and current trend (single mode)

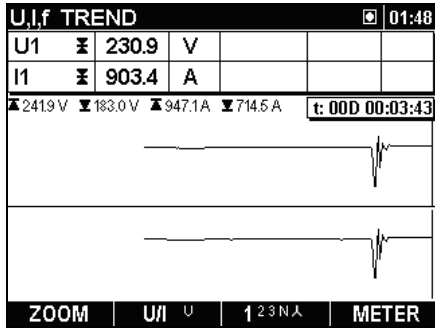

Figure 3.15: Voltage and current trend (dual mode)

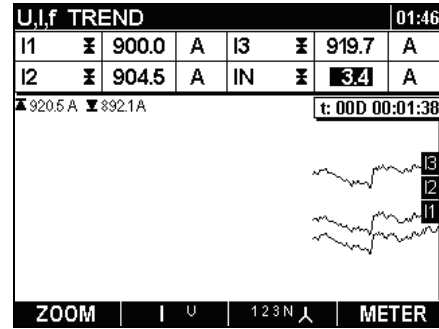

Figure 3.16: Trends of all currents

Table 3.7: Instrument screen symbols and abbreviations

	Current recorder status: RECORDER is active
	RECORDER is busy (retrieving data from memory).
20:45	Current instrument time
Up, Upg p: [1..3; N]	Maximal (\blacktriangle), average (\boxtimes) and minimal (\blacktriangledown) value of phase voltage U_{pRms} or line voltage U_{pgRms} for last recorded time interval (IP)
Ip p: [1..3, N]	Maximal (\blacktriangle), average (\boxtimes) and minimal (\blacktriangledown) value of current I_{pRms} for last recorded time interval (IP)
t: 00D 00:13:23	Current RECORDER time (Days hours:min.:sec.)
\blacktriangle 230.6 V \blacktriangledown 225.3 V	Maximal and minimal recorded voltage
\blacktriangle 947.1 A \blacktriangledown 0.0 A	Maximal and minimal recorded current

Table 3.8: Keys functions

	ZOOM+	Zoom in
	ZOOM+-	Zoom out
	U I	Select between the following options: Show voltage trend
	I U+	Show current trend
	U+I U/I	Show voltage and current trend (single mode)
	U/I U	Show voltage and current trend (dual mode)
	1 2 3 N A	Select between phase, neutral, all-phases and view: Show trend for phase L1
	1 2 3 N A	Show trend for phase L2
	1 2 3 N A	Show trend for phase L3
	1 2 3 N A	Show trend for neutral channel

	1 2 3 N	Summary of all phases trends
	METER	Switch to METER view.
	SCOPE	Switch to SCOPE view
	TREND	Switch to TREND view
		Return to the “MEASUREMENTS” menu screen.

Frequency trend

Frequency trend can be seen from METER screen by pressing function key F2.

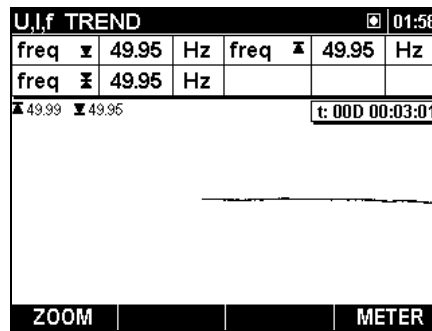

Figure 3.17: U, I, f frequency trend screen

Table 3.9: Instrument screen symbols and abbreviations

	Current recorder status: RECORDER is active
	RECORDER is busy (retrieving data from memory)
20:45	Current instrument time
f	Maximal (▲), average (⚡) and minimal (▾) value of frequency at synchronization channel for last recorded time interval (IP)
t: 00D 00:13:23	Current RECORDER time (Days hours:min.:sec.)
▲ 49.99 ▾ 49.95	Maximal and minimal frequency on displayed graph

Table 3.10: Keys functions

	ZOOM+	Zoom in
	ZOOM-	Zoom out
	METER	Return to METER view
		Return to the “MEASUREMENTS” menu screen.

3.3 Power menu

In POWER menu instrument show measured power parameters. Results can be seen in a tabular (METER) or a graphical form (TREND). TREND view is active only while RECORDER is active. See section 3.9 for instructions how to start recorder. In order to fully understand meanings of particular power parameter see sections 5.1.5 and 5.1.6.

3.3.1 Meter

By entering POWER menu from Measurements menu the POWER – METER tabular screen is shown (see figure below). METER screen show power, voltage and current signatures.

POWER METER				
	L1	L2	L3	Total
P	10.75	10.92	-22.06	- 0.39 kW
Q	18.69	-18.72	0.67	0.64 kVAr
S	21.56	21.67	22.07	0.75 kVA
pf	+0.49i	+0.50c	-0.99c	-0.52c
dPf	+0.49i	+0.50c	-1.00c	
U	234.5	235.8	235.8	V
I	91.93	91.90	93.61	A
HOLD			123人△	

Figure 3.18: Power measurements summary

POWER METER			
	L1		
P	10.89 kW	pf	+0.50i
Q	18.85 kVAr	dPf	+0.49i
S	21.77 kVA	TAN	----
U		I	
RMS	235.8 V		92.33 A
THD	8.2 V		4.44 A
THD	3.4 %		4.8 %
CF	1.37		1.40
HOLD			123人△

Figure 3.19: Detailed Power measurements at phase L1

Description of symbols and abbreviations used in METER screens are shown in table below.

Table 3.11: Instrument screen symbols and abbreviations





L1 L2 L3	Show currently displayed channel.
人 △	
	Current recorder status:
	RECORDER is active
	RECORDER is busy (retrieving data from memory)
	RECORDER is not active
20:45	Current instrument time
P, Q, S	Instantaneous active (P), reactive (Q) and apparent (S) power
PF, DPF	Instantaneous power factor (PF) and displacement power factor (cos φ)
U	True effective value U_{Rms}
I	True effective value I_{Rms}
RMS	True effective value U_{Rms} and I_{Rms}
THD	Total harmonic distortion THD_U and THD_I
CF	Crest factor Cf_U and Cf_I

Table 3.12: Keys functions

F1	WAVEFORM	Waveform snapshot:
	HOLD	Hold measurement on display
	SAVE	Save held measurement into memory
F3	VIEW	Select between phase, neutral, all-phases and line view:
	1 2 3 A Δ	Show measurements for phase L1
	1 2 3 A Δ	Show measurements for phase L2
	1 2 3 A Δ	Show measurements for phase L3
	1 2 3 A Δ	Summary of all phases measurements
	1 2 3 A Δ	Show phase-to-phase voltages measurements
F4	METER	Switch to METER view (available only during recording)
	TREND	Switch to TREND view (available only during recording)
ESC		Exit from "HOLD" screen without saving Return to the "MEASUREMENTS" menu screen.

3.3.2 Trend

During active recording TREND view is available (see section 3.9 for instructions how to start RECORDER).

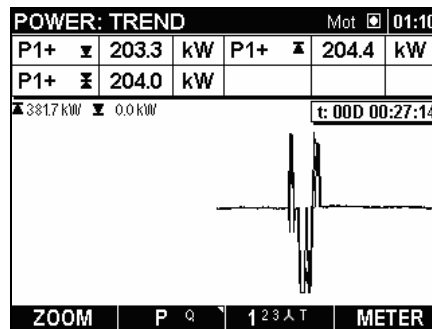

Figure 3.20: Power trend screen

Table 3.13: Instrument screen symbols and abbreviations

	Current recorder status
	RECORDER is active
	RECORDER is busy (retrieving data from memory)
Mot	Show selected power mode:
Gen	Consumed power data (+) are shown
	Generated power data (-) are shown
20:45	Current instrument time
Pp±, Pt± p: [1..3]	Maximal (▲), average (⌘) and minimal (▼) value of consumed (P ₁ ⁺ , P ₂ ⁺ , P ₃ ⁺ , P _{tot} ⁺) or generated (P ₁ ⁻ , P ₂ ⁻ , P ₃ ⁻ , P _{tot} ⁻) active power for last recorded time interval (IP)

Qip±, Qit± p: [1..3]	Maximal (⏏), average (⏏) and minimal (⏏) value of consumed (Q_{i1}^+ , Q_{i2}^+ , Q_{i3}^+ , Q_{itot}^+) or generated (Q_{i1}^- , Q_{i2}^- , Q_{i3}^- , Q_{itot}^-) reactive inductive power (Q_{i1}^\pm , Q_{i2}^\pm , Q_{i3}^\pm , Q_{itot}^\pm) for last recorded time interval (IP)
Qcp±, Qct± p: [1..3]	Maximal (⏏), average (⏏) and minimal (⏏) value of consumed (Q_{c1}^+ , Q_{c2}^+ , Q_{c3}^+ , Q_{ctot}^+) or generated (Q_{c1}^- , Q_{c2}^- , Q_{c3}^- , Q_{ctot}^-) reactive capacitive power (Q_{c1}^\pm , Q_{c2}^\pm , Q_{c3}^\pm , Q_{ctot}^\pm) for last recorded time interval (IP)
Sp±, St± p: [1..3]	Maximal (⏏), average (⏏) and minimal (⏏) value of consumed apparent power (S_1^+ , S_2^+ , S_3^+ , S_{tot}^+) or generated apparent power (S_1^- , S_2^- , S_3^- , S_{tot}^-) for last recorded time interval (IP)
PFip±, PFit± p: [1..3]	Maximal (⏏), average (⏏) and minimal (⏏) value of inductive power factor (1 st quadrant: PF_{i1}^+ , PF_{i2}^+ , PF_{i3}^+ , PF_{itot}^+ and 3 rd quadrant: PF_{i1}^- , PF_{i2}^- , PF_{i3}^- , PF_{itot}^-) for last recorded time interval (IP)
PFcp±, PFt± p: [1..3]	Maximal (⏏), average (⏏) and minimal (⏏) value of capacitive power factor (4 th quadrant: PF_{c1}^+ , PF_{c2}^+ , PF_{c3}^+ , PF_{ctot}^+ and 2 nd quadrant: PF_{c1}^- , PF_{c2}^- , PF_{c3}^- , PF_{ctot}^-) for last recorded time interval (IP)
t: 00D 00:13:23	Current RECORDER time (Days hours:min.:sec.)
⏏ 381.7 kW ⏏ 0.0 kW	Maximal and minimal recorded quantity

Table 3.14: Keys functions

F1	ZOOM+ Zoom in ZOOM+ Zoom out																
F2 Press & Hold	Toggle between consumed or generated power parameters view: <table border="1" style="margin-left: 20px;"> <tr> <th colspan="2">Measurement source type</th> </tr> <tr> <td>Motor</td> <td>Generator</td> </tr> </table>	Measurement source type		Motor	Generator												
Measurement source type																	
Motor	Generator																
F2	Select between trending various parameters: <table style="margin-left: 20px;"> <tr><td>P Qi</td><td>Active power</td></tr> <tr><td>Qi Qc</td><td>Reactive inductive power</td></tr> <tr><td>Qc S</td><td>Reactive capacitive power</td></tr> <tr><td>S PFI</td><td>Apparent power</td></tr> <tr><td>PFI PFC</td><td>Inductive power factor</td></tr> <tr><td>PFC DPFI</td><td>Capacitive power factor</td></tr> <tr><td>DPFI DPFC</td><td>Inductive displacement factor (cos φ)</td></tr> <tr><td>DPFC P</td><td>Capacitive displacement factor (cos φ)</td></tr> </table>	P Qi	Active power	Qi Qc	Reactive inductive power	Qc S	Reactive capacitive power	S PFI	Apparent power	PFI PFC	Inductive power factor	PFC DPFI	Capacitive power factor	DPFI DPFC	Inductive displacement factor (cos φ)	DPFC P	Capacitive displacement factor (cos φ)
P Qi	Active power																
Qi Qc	Reactive inductive power																
Qc S	Reactive capacitive power																
S PFI	Apparent power																
PFI PFC	Inductive power factor																
PFC DPFI	Capacitive power factor																
DPFI DPFC	Inductive displacement factor (cos φ)																
DPFC P	Capacitive displacement factor (cos φ)																
F3	Select between single phase, all-phases and total trend graph 1 2 3 入 T Power parameters for phase L1																

	Power parameters for phase L2
	Power parameters for phase L3
	Power parameters L1, L2 and L3 on the same graph
	Total power parameters
	METER Switch to METER view (available only during recording)
	TREND Switch to TREND view (available only during recording)
	Return to the “MEASUREMENTS” menu screen.

3.4 Energy menu

Instrument shows status of energy counters in energy menu. Results can be seen in a tabular (METER) form. For representing data in graph (TREND) form, download data to PC and use software PowerView v2.0. Energy measurement is active only if RECORDER is active. See section 3.9 for instructions how to start RECORDER. In order to fully understand meanings of particular energy parameter see section 5.1.7. The meter screens are shown on figures bellow.

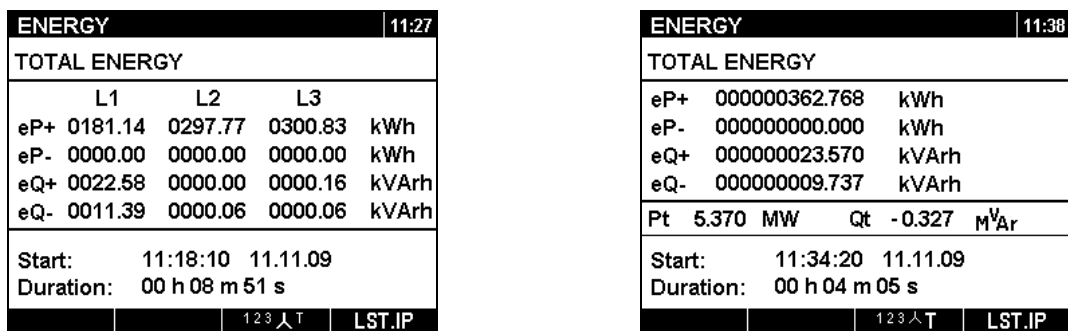



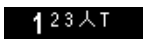









Figure 3.21: Energy counters screen

Table 3.15: Instrument screen symbols and abbreviations

	Current recorder status: RECORDER is active
	RECORDER is busy (retrieving data from memory)
	RECORDER is not active
20:45	Current instrument time
eP+	Consumed phase (eP ₁ ⁺ , eP ₂ ⁺ , eP ₃ ⁺) or total (eP _{tot} ⁺) active energy
eP-	Generated phase (eP ₁ ⁻ , eP ₂ ⁻ , eP ₃ ⁻) or total (eP _{tot} ⁻) active energy
eQ+	Consumed phase (eQ ₁ ⁺ , eQ ₂ ⁺ , eQ ₃ ⁺) or total (eQ _{tot} ⁺) reactive energy Note: eQ+ is two quadrant measurement. For separate measurements (eQ _i ⁺ , eQ _c ⁻) download data to PC and use software PowerView v2.0 in order to observe results.
eQ-	Generated phase (eQ ₁ ⁻ , eQ ₂ ⁻ , eQ ₃ ⁻) or total (eQ _{tot} ⁻) reactive energy Note: eQ- is two quadrant measurement. For four quadrant measurement

	(eQ_i^- , eQ_c^+) download data to PC and use software PowerView v2.0 in order to observe results.
Pp, Pt p: [1..3]	Instantaneous phase active power (P_1 , P_2 , P_3) or total P_{tot} active power
Qp, Qt p: [1..3]	Instantaneous reactive power (Q_1 , Q_2 , Q_3 , Q_{tot}) or total Q_{tot} reactive power
Start	Recorder start time and date
Duration	Current RECORDER time

Table 3.16: Keys functions

	Select between single phase and total energy meter
	 Energy parameters for phase L1
	 Energy parameters for phase L2
	 Energy parameters for phase L3
	 Summary for all phases energy
	 Energy parameters for Totals
	Toggle between time interval:
	 Show energy registers for last interval
	 Show energy registers for current interval
	 Show energy registers for whole record
	Return to the “MEASUREMENTS” menu screen.

3.5 Harmonics / interharmonics¹ menu

Harmonics presents voltage and current signals as a sum of sinusoids of power frequency and its integer multiples. Power frequency is called fundamental frequency. Sinusoidal wave with frequency k times higher than fundamental (k is an integer) is called harmonic wave and is denoted with amplitude and a phase shift (phase angle) to a fundamental frequency signal. If a signal decomposition with Fourier transformation results with presence of a frequency that is not integer multiple of fundamental, this frequency is called interharmonic frequency and component with such frequency is called interharmonic. See 5.1.8 for details.

3.5.1 Meter

By entering HARMONICS menu from MEASUREMENTS menu the HARMONICS – METER tabular screen is shown (*see figure below*). In this screens voltage and current harmonics or interharmonics and THD are shown.

¹ Interharmonics measurement are available only in PowerQ4 Plus

HARMON. METER						INTERHARM. METER					
U1		I1		U2		I2		U3		I3	
V	A	V	A	V	A	V	A	V	A	V	A
RMS	229.8	1769	230.2	1766	230.1	1768	RMS	229.9	1769	229.7	1772
THD	2.1	15.9	2.1	14.6	2.1	15.7	THD	1.2	1.0	1.2	1.1
h 1	229.7	1768	230.1	1766	230.0	1768	ih 1	0.3	0.3	0.3	0.3
h 2	0.3	0.9	0.3	2.1	0.4	3.7	ih 2	0.2	0.3	0.2	0.3
h 3	0.2	1.5	0.3	1.4	0.4	2.0	ih 3	0.3	0.3	0.3	0.2
h 4	0.2	2.1	0.4	1.8	0.4	3.4	ih 4	0.3	0.4	0.2	0.3
HOLD		V-A %		1 2 3 N Δ		BAR		HOLD		% V-A 1 2 3 N Δ	

Figure 3.22: Harmonics and interharmonics meter table

Description of symbols and abbreviations used in METER screens are shown in table below.

Table 3.17: Instrument screen symbols and abbreviations

	Show currently displayed channel.
	Current recorder status:
	RECORDER is active
	RECORDER is busy (retrieving data from memory)
	RECORDER is not active
	Current instrument time
RMS	True effective value U_{Rms} and I_{Rms}
THD	Total harmonic / interharmonic distortion THD_U and THD_I
hn	n-th harmonic / interharmonic voltage U_{h_n} or current I_{h_n} component
n: 0..50	

Table 3.18: Keys functions

	Waveform snapshot:
	Hold measurement on display
	Save held measurement into memory
	Toggle harmonics / interharmonics measurement view
Press & Hold	
	Represent harmonics / interharmonics as % of first harmonic RMS value
	Represent values in RMS quantities (Volts, Ampere)
	Select between single phase, neutral, all-phases and line harmonics / interharmonics view

	Harmonics / interharmonics components for phase L1
	Harmonics / interharmonics components for phase L2
	Harmonics / interharmonics components for phase L3
	Harmonics / interharmonics components for neutral channel
	Summary of components on all phases
	Harmonics / interharmonic components for phase-to-phase voltages
	METER Switch to METER view
	BAR Switch to BAR view
	TREND Switch to TREND view (available only during recording)
	Shift through harmonic / interharmonic components
	Exit from "HOLD" screen without saving. Return to the "MEASUREMENTS" menu screen.

3.5.2 Histogram (Bar)

Bar screen displays dual bar graphs. The upper bar graph shows voltage harmonics and the lower bar graph shows current harmonics.

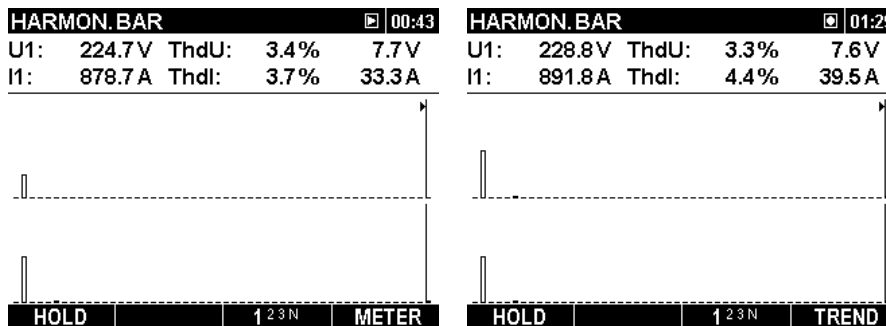

Figure 3.23: Harmonics histogram screens







Description of symbols and abbreviations used in BAR screens are shown in table below.

Table 3.19: Instrument screen symbols and abbreviations

	Current recorder status: RECORDER is active
	RECORDER is busy (saving data to memory)
	RECORDER is not active
	Current instrument time
	Show selected harmonic / interharmonic component
Up, Un p:1..3	True effective phase or line voltage U_{Rms}

I_p, I_n p:1..3	True effective phase current I_{Rms}
ThdU	Total voltage harmonic distortion THD_U
ThdI	Total current harmonic distortion THD_I
hn/ihn n: 0..50	n-th voltage or current harmonic / interharmonic component U_{h_n}/iU_{h_n} or I_{h_n}/iI_{h_n}

Table 3.20: Keys functions

	WAVEFORM	Waveform snapshot:
	HOLD	Hold measurement on display
	SAVE	Save held measurement into memory
	1 2 3 N	Select between single phases, neutral, harmonics bars
	1 2 3 N	Harmonics / interharmonics components for phase L1
	1 2 3 N	Harmonics / interharmonics components for phase L2
	1 2 3 N	Harmonics / interharmonics components for phase L3
	1 2 3 N	Harmonics / interharmonics components for neutral channel
	METER	Switch to METER view
	BAR	Switch to BAR view
	TREND	Switch to TREND view (available only during recording)
	ENTER	Toggle cursor between voltage and current histogram
	↑ ↓	Scale displayed histogram by amplitude
	← →	Scroll cursor to select single harmonic / interharmonic bar
	ESC	Exit from "HOLD" screen without saving. Return to the "MEASUREMENTS" menu screen.

3.5.3 Trend

During active RECORDER, TREND view is available (see section 3.9 for instructions how to start RECORDER). Voltage and current harmonics / interharmonics components can be observed by cycling function key F4 (METER-BAR-TREND).

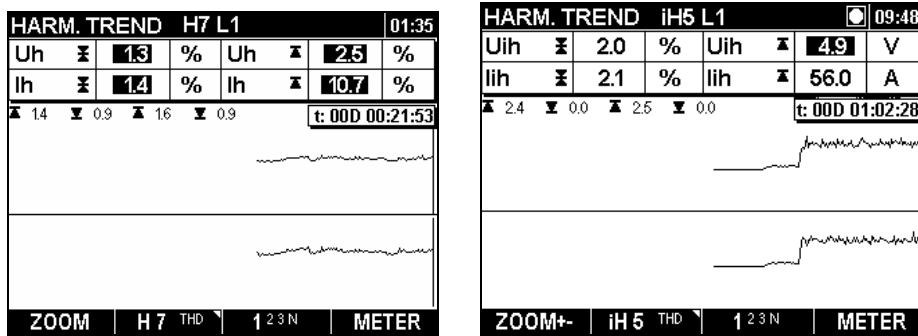

Figure 3.24: Harmonics and interharmonics trends screens

Table 3.21: Instrument screen symbols and abbreviations

	Current recorder status: RECORDER is active
	RECORDER is busy (retrieving data from memory)
	Current instrument time
ThdU	Maximal (▲) and average (⊗) value of total voltage harmonic distortion THD _U for selected phase
ThdI	Maximal (▲) and average (⊗) value of total current harmonic distortion THD _I for selected phase
Uh/Uih	Maximal (▲) and average (⊗) value for selected n-th voltage harmonic / interharmonic component for selected phase
Ih/Iih	Maximal (▲) and average (⊗) value of selected n-th current harmonic / interharmonic component for selected phase
	Current RECORDER time (Days hours:min.:sec.)
	Maximal (▲) and minimal (▼) recorded quantity
	Maximal (▲) and minimal (▼) recorded quantity

Table 3.22: Keys functions



ZOOM+ Zoom in
ZOOM+- Zoom out

Select:

Max. 3 harmonics / interharmonics for observing trend

Harmonics/interharmonics units:















- % of first harmonics /interharmonics,
- absolute units (Volts/Ampere)



Press &
Hold

SELECT HARMONICS								
1	2	3	4	5	6	7	8	9
10	11	12	13	14	15	16	17	18
19	20	21	22	23	24	25	26	27
28	29	30	31	32	33	34	35	36
37	38	39	40	41	42	43	44	45
46	47	48	49	50	%	V.A		





HARMS			INTERHARMS					
1	2	3	4	5	6	7	8	9
10	11	12	13	14	15	16	17	18
19	20	21	22	23	24	25	26	27
28	29	30	31	32	33	34	35	36
37	38	39	40	41	42	43	44	45
46	47	48	49	50	%	V.A		

		Select between trending various parameters. By default these are:
		Total harmonic distortion for selected phase (THDU _p)
		3 rd harmonics / interharmonics for selected phase (U _p h ₃)
		5 th harmonics / interharmonics for selected phase (U _p h ₅)
		7 th harmonics / interharmonics for selected phase (U _p h ₇)
		Select between single phase, neutral, all-phases and line harmonics view
		Harmonics / interharmonics components for phase L1 (U ₁ h _n)
		Harmonics / interharmonics components for phase L2 (U ₂ h _n)
		Harmonics / interharmonics components for phase L3 (U ₃ h _n)
		Harmonics / interharmonics components for neutral channel (U _N h _n)
		Switch to METER view
		Switch to BAR view
		Switch to TREND view (available only during recording)
		Return to the “MEASUREMENTS” menu screen.

Selection of harmonics / interharmonics for observing trend

Max. 3 harmonics / interharmonics can be selected. Press and hold F2 key in TREND screen and a spreadsheet for selection will open. Note that only recorded harmonics / interharmonics can be selected. For setting recording parameters see section 3.9

Table 3.23: Keys functions

		Select or deselect harmonics / interharmonics in a spreadsheet
		Cursor keys (for moving trough a spreadsheet)
		Confirms selection of harmonics / interharmonics for observing trend.
		Cancels selection of harmonics / interharmonics for observing trend without changes.

3.6 Flickermeter

Flickermeter measures the human perception of the effect of amplitude modulation on the mains voltage powering a light bulb. In Flickermeter menu instrument shows measured flicker parameters. Results can be seen in a tabular (METER) or a graphical form (TREND) - which is active only while RECORDER is active. See section 3.9 for instructions how to start recording. In order to understand meanings of particular parameter see section 5.1.9.

3.6.1 Meter

By entering FLICKERMETER menu from MEASUREMENTS menu the FLICKERMETER tabular screen is shown (see figure below).

FLICKERMETER ▶ 01:59			
	L1	L2	L3
Urms	230.6	228.3	230.0 V
Pst (1min)	0.575	0.764	0.464
Pst	0.517	0.666	0.542
Plt	2.090	2.305	1.338
HOLD			TREND

Figure 3.25: Flickermeter table screen

Description of symbols and abbreviations used in METER screen is shown in table below.

Table 3.24: Instrument screen symbols and abbreviations











	Current recorder status: RECORDER is active
	RECORDER is busy (retrieving data from memory)
	RECORDER is not active
	Current instrument time
Urms	True effective value U_{Rms}
Pst(1min)	Short term (1 min) flicker P_{st1min}
Pst	Short term (10 min) flicker P_{st}
Plt	Long term flicker (2h) P_{st}
	Inverted colors represent that measurement is not valid (in case of voltage overrange, voltage dips, low voltage, etc.)

Table 3.25: Keys functions

	Waveform snapshot:
	Hold measurement on display
	Save held measurement into memory

	METER	Switch to METER view (available only during recording)
	TREND	Switch to TREND view (available only during recording)
		Exit from "HOLD" screen without saving. Return to the "MEASUREMENTS" menu screen.

3.6.2 Trend

During active recording TREND view is available (see section 3.9 for instructions how to start recording). Flicker parameters can be observed by cycling function key F4 (METER -TREND).

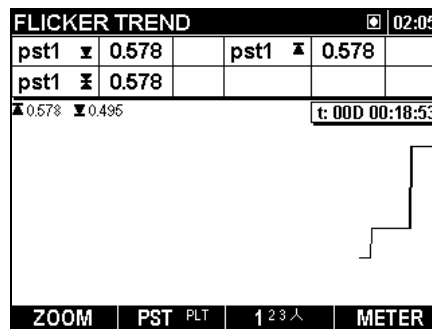

Figure 3.26: Flicker meter trend screen.

Table 3.26: Instrument screen symbols and abbreviations





	Current recorder status: RECORDER is active
	RECORDER is busy (retrieving data from memory)
20:45	Current instrument time
pstmp p: [1..3]	Maximal (▲), average (⊠) and minimal (▼) value of 1-minute short term flicker P_{st1min} for phase voltages U_1, U_2, U_3 or line voltages U_{12}, U_{23}, U_{31}
pstp p: [1..3]	Maximal (▲), average (⊠) and minimal (▼) value of 10-minutes short term flicker P_{st} for phase voltages U_1, U_2, U_3 or line voltages U_{12}, U_{23}, U_{31}
pltp p: [1..3]	Maximal (▲), average (⊠) and minimal (▼) value of 2-hours long term flicker P_{lt} in phase voltages U_1, U_2, U_3 or line voltages U_{12}, U_{23}, U_{31}
t: 00D 00:13:23	Current RECORDER time (Days hours:min.:sec.)
▲0.578 ▼0.495	Maximal and minimal recorded flicker

Table 3.27: Keys function

	ZOOM+	Zoom in
	ZOOM-	Zoom out
		Select between the following options:
	PST PLT	Show 10 min short term flicker P_{st}

	PLT <small>PSTMIN</small>	Show long term flicker P_{lt}
	PSTMIN <small>PST</small>	Show 1 min short term flicker P_{st1min}
		Select between trending various parameters:
F3	1 <small>23</small> <small>人</small>	Show selected flicker trends for phase 1
	12 <small>3</small> <small>人</small>	Show selected flicker trends for phase 2
	123 <small>人</small>	Show selected flicker trends for phase 3
	123 <small>人</small>	Show selected flicker trends for all phase (average only)
F4	METER	Switch to METER view
	TREND	Switch to TREND view
ESC		Return to the "MEASUREMENTS" menu screen.

3.7 Phase Diagram

Phase diagram graphically represent fundamental voltages, currents and phase angles of the network. This view is strongly recommended for checking instrument connection before measurement. Note that most measurement issues arise from wrongly connected instrument (see 4.1 for recommended measuring practice). On phase diagram instrument shows:

- Graphical presentation of voltage and current phase vectors of the measured system,
- Unbalance of the measured system.

3.7.1 Phase diagram

By entering PHASE DIAGRAM menu from MEASUREMENTS menu following screen is shown (see figure below).

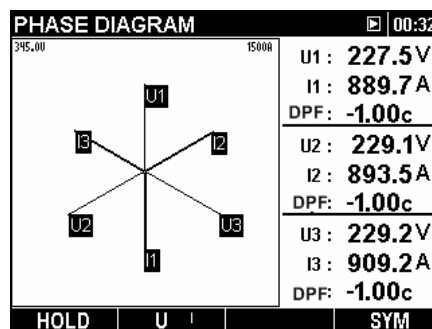

Figure 3.27: Phase diagram screen.

Table 3.28: Instrument screen symbols and abbreviations

	Current recorder status:
	RECORDER is active
	RECORDER is busy (retrieving data from memory)
	RECORDER is not active

20:45	Current instrument time
U1, U2, U3	Fundamental voltages U_{1Fnd} , U_{2Fnd} , U_{3Fnd}
I1, I2, I3	Fundamental currents I_{1Fnd} , I_{2Fnd} , I_{3Fnd}
DPF	Displacement factor (cos ϕ) for particular phase: DPF ₁ , DPF ₂ , DPF ₃
345.00 1500A	Indicate current and voltage scaling. Value represents current or voltage value at the top of the graph (top horizontal line).

Table 3.29: Keys function

F1	HOLD	Waveform snapshot: Hold measurement on display
	SAVE	Save held measurement into memory
F2	U I	Selects voltage for scaling (with cursors)
	I U	Selects current for scaling (with cursors)
F4	U-I	Switch to phase diagram
	SYM	Switch to symmetry diagram
	TREND	Switch to TREND view (available only during recording)
ENTER		Show details about the selected event.
▲ ▼		Scale displayed diagram by amplitude.
ESC		Exit from "HOLD" screen without saving. Back to the "MEASUREMENTS" menu.

3.7.2 Symmetry diagram

Symmetry diagram represent current and voltage symmetry or unbalance of the measuring system. Unbalance arises when RMS values or phase angles between consecutive phases are not equal. Diagram is shown on figure bellow.

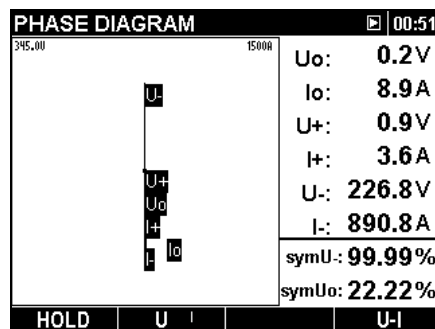

Figure 3.28: Symmetry diagram screen

Table 3.30: Instrument screen symbols and abbreviations

	Current recorder status: RECORDER is active
	RECORDER is busy (retrieving data from memory)
	RECORDER is not active
	Current instrument time
U0	Zero sequence voltage component U^0
I0	Zero sequence current component I^0
U+	Positive sequence voltage component U^+
I+	Positive sequence current component I^+
U-	Negative sequence voltage component U^-
I-	Negative sequence current component I^-
symU-	Negative sequence voltage ratio u^-
symI-	Negative sequence current ratio i^-
symU+	Zero sequence voltage ratio u^0
symI-	Zero sequence current ratio i^0
	Indicate current and voltage scaling. Value represents current or voltage value at the top of the graph (top horizontal line).

Table 3.31: Keys function

	Waveform snapshot:
	• Hold measurement on display
	• Save held measurement into memory
	Toggle u^-/u^0 voltages and select voltage for scaling (with cursors)
	Toggle i^-/i^0 currents and select currents for scaling (with cursors)
	Switch to phase diagram
	Switch to symmetry diagram
	Switch to TREND view (available only during recording)
	Scale displayed diagram by amplitude.
	Back to the "MEASUREMENTS" menu.

3.7.3 Symmetry trend

During active recording SYMETRY TREND view is available (see section 3.9 for instructions how to start RECORDER).

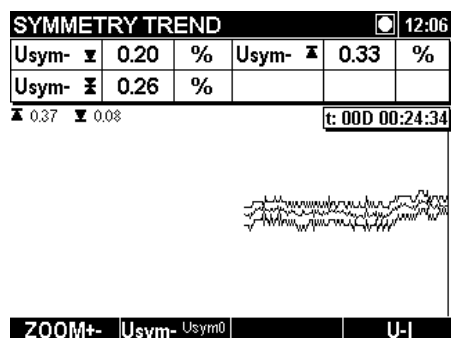

Figure 3.29: Symmetry trend screen

Table 3.32: Instrument screen symbols and abbreviations

	Current recorder status:
	RECORDER is active
	RECORDER is busy (retrieving data from memory)
	Current instrument time
Usym-	Maximal (), average () and minimal () value of negative sequence voltage ratio u^- for last recorded time interval (IP)
Usym0	Maximal (), average () and minimal () value of zero sequence voltage ratio u^0 for last recorded time interval (IP)
Isym-	Maximal (), average () and minimal () value of negative sequence current ratio i^- for last recorded time interval (IP)
Isym0	Maximal (), average () and minimal () value of zero sequence current ratio i^0 for last recorded time interval (IP)
	Current RECORDER time (Days hours:min.:sec.)
	Maximal () and minimal () recorded quantity

Table 3.33: Keys functions

		Zoom in
		Zoom out
		Negative sequence voltage ratio view
		Zero sequence voltage ratio view
		Negative sequence current ratio view
		Zero sequence current ratio view
		Switch to phase diagram
		Switch to symmetry diagram
		Switch to TRENDS view (available only during recording)
		Back to the “MEASUREMENTS” menu screen.

3.8 Temperature

PowerQ4 Plus instruments is capable of measuring and recording temperature. Temperature is expressed in both units, Celsius and Fahrenheit degrees. See following sections for instructions how to start recording. In order to learn how to set up neutral clamp input with the temperature sensor, see section 4.2.4.

3.8.1 Meter

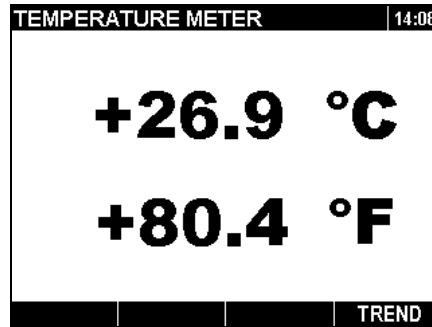

Figure 3.30: Temperature meter screen

Table 3.34: Instrument screen symbols and abbreviations







	Current recorder status
	<ul style="list-style-type: none"> Instrument is recording
	<ul style="list-style-type: none"> Instrument is busy. (saving data to memory)
	<ul style="list-style-type: none"> Instrument is not in recording mode
	Current instrument time

Table 3.35: Keys function

		Switch to TREND view (available only during recording)
		Return to the "MEASUREMENTS" menu screen.

3.8.2 Trend

Temperature measurement trend can be viewed only during the recording in progress. Records containing temperature measurement can be viewed by using PC software PowerView v2.0.

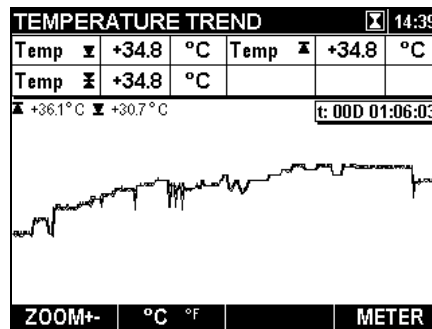

Figure 3.31: Temperature trend screen

Table 3.36: Instrument screen symbols and abbreviations

	Current recorder status
	<ul style="list-style-type: none"> Instrument is recording Instrument is busy (saving data to memory)
20:45	Current instrument time
Temp:	Maximal (▲), average (☒) and minimal (▾) temperature value for last recorded time interval (IP)
t: 00D 00:13:23	Current RECORDER time (Days hours:min.:sec.)
▲ +36.1°C ▾ +30.7°C	Maximal and minimal temperature value on displayed graph

Table 3.37: Keys functions

F1	ZOOM+	Zoom in
	ZOOM+-	Zoom out
F2	°C °F	Toggle temperature scale (Celsius / Fahrenheit degrees)
F4	METER	Switch to METER view
ESC		Return to the “MEASUREMENTS” menu screen.

3.9 General Recorder

PowerQ4 Plus has ability to record measured data in the background. In RECORDER menu user can customize recorder parameters in order to meet his criteria about type, duration, and the number of signals for the recording campaign. By entering “RECORDER” menu, following screen is shown:

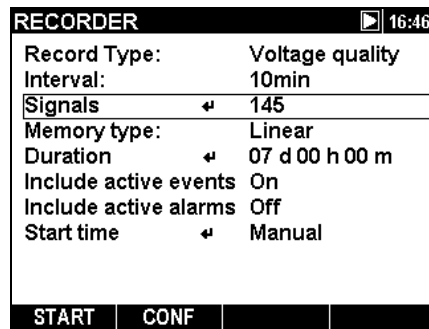
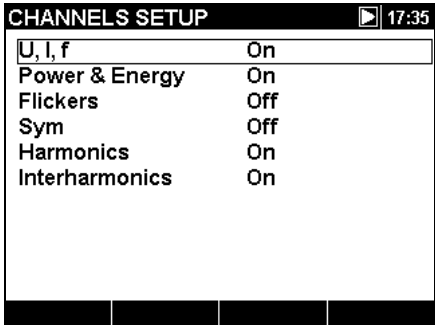

Figure 3.32: Basic recorder setup screen







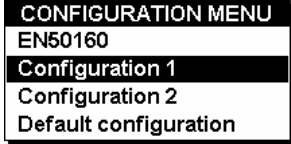

In following table description of recorder settings is given:

Table 3.38: Recorder settings description

<p>Record Type</p>	<p>Select type of recording. Following options are available and can be set by using configuration menu:</p> <ul style="list-style-type: none"> Record (user defined) Voltage quality (according to EN 50160)
<p>Interval</p>	<p>Select recorder aggregation interval. For each time interval minimal, average and maximal value will be recorded (for each signal). The smaller the interval is, more measurements will be used for the same record duration.</p> <p>Note: The instrument automatically changes the duration in case there is not enough memory for the desired interval and duration.</p> <p>Note: EN 50160 record type stores only average values per interval.</p>
<p>Signals</p>	<p>Select signals to record. See 4.2.5 for detail channel list.</p>  <p>The 'CHANNELS SETUP' screenshot shows the following options: U, I, f (On); Power & Energy (On); Flickers (Off); Sym (Off); Harmonics (On); Interharmonics (On). At the bottom, there are four buttons.</p> <ul style="list-style-type: none"> U, I, f – select voltage, current and freq. parameters for recording. Power & Energy – select power and energy parameters for recording. Flickers – select flicker parameters for recording. Sym – select unbalance parameters for recording.

	<ul style="list-style-type: none"> • Harmonics – select which voltage and current harmonics you want to include in the record. <div data-bbox="826 271 1166 405" style="border: 1px solid black; padding: 5px; margin: 10px 0;"> <p style="text-align: center; margin: 0;">HARMONICS SETUP</p> <p>Voltage <input type="text" value="1"/> → 50 All</p> <p>Current 1 → 50 All</p> </div> <p>User can choose:</p> <ul style="list-style-type: none"> ○ First and last voltage and current harmonic to record; ○ Select even, odd or all harmonics components for recording. <ul style="list-style-type: none"> • Interharmonics – select which voltage and current interharmonics you want to include in the record. <p>Note: If only harmonics or interharmonics are selected, user can select up to the 50th harmonic / interharmonic component. In the case of combined harmonics and interharmonics selection user can choose up to the 25th harmonic / interharmonic component for recording.</p>
<p>Memory type</p>	<p>Select recorder memory type:</p> <ul style="list-style-type: none"> • Linear – normal recorder, which start and stop in accordance to user settings. • Circular – when recorded data exceeds free memory, oldest data in the current recording will be overwritten with the newest. Amount of recorded aggregation intervals is limited by free flash memory before recording start.
<p>Duration</p>	<p>Select the duration of the record.</p> <div data-bbox="820 1198 1171 1294" style="border: 1px solid black; padding: 5px; margin: 10px 0;"> <p style="text-align: center; margin: 0;">SET DURATION</p> <p><input type="text" value="07"/> Day 00 Hour 00 Min</p> </div> <p>Note: If the set duration time is longer than memory allows it, it will be automatically shortened.</p>
<p>Include active events</p>	<p>Select whether you want to include active events in record.</p>
<p>Include active alarms</p>	<p>Select whether you want to include active alarms in record.</p>
<p>Start time</p>	<p>Define start time of recording:</p> <ul style="list-style-type: none"> • Manual, pressing function key F1 • Add predefined start time, when recorder should start <div data-bbox="887 1668 1102 1792" style="border: 1px solid black; padding: 5px; margin: 10px 0;"> <p style="text-align: center; margin: 0;">SET START TIME</p> <p style="text-align: center; margin: 0;"><input type="text" value="01:03:00"/></p> <p style="text-align: center; margin: 0;">01.01.00</p> </div>

Table 3.39: Keys functions

	START STOP	Start the recorder Stop the recorder
		Open configuration sub menu.
		
		Possible options are:
		<ul style="list-style-type: none"> • “EN50160” – predefined configuration for EN 50160 survey. • Configuration 1 - user defined configuration. • Configuration 2 - user defined configuration. • “Default configuration” – factory defaults.
	CONF	
		<p>Note: EN 50160 configuration records only average values for defined time period.</p> <p>Note: EN 50160 by default records voltage parameters only. Current, power and other dependent quantities are not recorded nor shown in trend graphs by default. Using SIGNALS menu user can add power or currents channels and perform EN 50160 and power measurement simultaneously.</p>
	LOAD	Load the selected configuration (active in configuration sub menu).
	SAVE	Save the changes to the selected configuration (active in configuration sub menu).
		Enter the selected submenu.
		Select parameter / change value.
		Select parameter / change value.
		Back to the previous menu.

3.10 Waveform recorder

Waveform recording is a powerful tool for troubleshooting and capturing current and voltage waveforms. Waveform method saves a defined number of periods of selected voltage and current signals on a trigger occurrence. Each recording consists of pretrigger buffer (before trigger occur) and store buffer (after trigger occurred).

3.10.1 Setup

By entering “WAVEFORM RECORDER” from the “RECORDERS” menu screen the “WAVEFORM RECORDER” setup screen is shown.

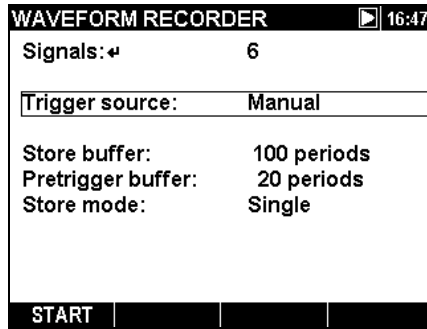









Figure 3.33: Waveform recorder setup screen.

Table 3.40: Instrument screen symbols and abbreviations

<p>Signals</p>	<p>Select logging signals:</p> <div style="text-align: center;"> <table border="1" data-bbox="868 757 1110 860"> <tr> <th colspan="4">SIGNALS</th> </tr> <tr> <td>U1</td> <td>U2</td> <td>U3</td> <td>Un</td> </tr> <tr> <td>I1</td> <td>I2</td> <td>I3</td> <td>In</td> </tr> </table> </div>	SIGNALS				U1	U2	U3	Un	I1	I2	I3	In
SIGNALS													
U1	U2	U3	Un										
I1	I2	I3	In										
<p>Trigger source</p>	<p>Trigger source set up:</p> <ul style="list-style-type: none"> • Manual - triggered by a F1 - TRIG key; • Events – triggered by voltage event; • Alarms – triggered by alarm activation; • Events & Alarms – Voltage or alarm event triggers recording. <p>Note: actual trigger settings can be set in voltage events and alarm configuration</p>												
<p>Store buffer</p>	<p>Number of periods to be recorded.</p>												
<p>Pretrigger buffer</p>	<p>Pre – trigger buffer length (number of periods).</p>												
<p>Store mode</p>	<p>Store mode setup:</p> <ul style="list-style-type: none"> • Single – waveform recording ends after first trigger; • Continuous – consecutive waveform recording until user stop the measurement or instrument runs out of storage memory. Every consecutive waveform recording will be treated as a separate record. 												

Table 3.41: Keys functions

<p></p>	<p>START STOP</p>	<p>Start waveform recorder. Stop waveform recording. Note: If user forces waveform recorder to stop no data is recorded. Data recording occurs only when trigger is activated.</p>
<p></p>	<p>TRIG</p>	<p>Manually generate trigger condition (Active only if Manual trigger is selected and recording is in progress).</p>
<p></p>	<p>SET</p>	<p>Selecting and deselecting signals for waveform recording in the SIGNALS dialog box.</p>
<p></p>	<p>SCOPE</p>	<p>Switch to SCOPE view. If SIGNALS dialog box is open, scroll through all channels.</p>

	<p>If "Trigger source" is selected, change Trigger source. If SIGNALS dialog box is open, scroll through all channels. If "Store buffer" is selected, change Store buffer size. If "Pre – trigger length" is selected, change pre – trigger buffer size.</p>
	<p>Open SIGNALS dialog box (if "Signals" is selected). In this dialog box the individual signals can be selected for recording.</p>
	<p>Return to the "RECORDERS" menu screen or close the SIGNALS dialog box (if the dialog box is open).</p>

3.10.2 Capturing waveform

Following screen opens when a user starts the waveform recorder.

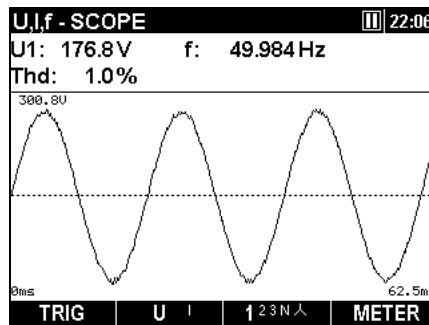

Figure 3.34: Waveform recorder capture screen.

Table 3.42: Instrument screen symbols and abbreviations







	<p>Current instrument status:</p> <ul style="list-style-type: none"> • Instrument is waiting for trigger to happen. • Instrument is recording (beep indicates that trigger limit has been reached). • Instrument is busy (saving data to memory).
	
	
20:45	Current instrument time
Up p: [1..3, N]	True effective value of phase voltage: $U_{1Rms}, U_{2Rms}, U_{3Rms}, U_{NRms}$
Upg p,g: [1, 2, 3]	True effective value of phase-to-phase (line) voltage: $U_{12Rms}, U_{23Rms}, U_{31Rms}$
Ip p: [1..3, N]	True effective value of current: $I_{1Rms}, I_{2Rms}, I_{3Rms}, I_{NRms}$
Thd	Total harmonic distortion for displayed quantity (THD _U or THD _I)
f	Frequency on reference channel

Table 3.43: Keys functions

	TRIG	Manually generate trigger condition (Active only if Manual trigger is selected and recording is in progress).
	 	Select which waveforms to show: Show voltage waveform; Show current waveform ;

	U+I $U+I$	Show voltage and current waveform (single mode);
	U/I U/I	Show voltage and current waveform (dual mode).
		Select between phase, neutral, all-phases and line view:
	1 2 3 N \curvearrowright	• Show waveforms for phase L1;
	1 2 3 N \curvearrowright	• Show waveforms for phase L2;
	1 2 3 N \curvearrowright	• Show waveforms for phase L3;
	1 2 3 N \curvearrowright	• Show waveforms for neutral channel;
	1 2 3 N \curvearrowright	• Summary of all phases waveforms;
	1 2 3 Δ	• Show phase-to-phase voltages.
	METER	Switch to METER view.
	SCOPE	Switch to SCOPE view.
		Select which waveform to zoom (only in U/I or U+I).
		Set vertical zoom.
		Set horizontal zoom.
		Return to the “WAVEFORM RECORDER” setup screen.

3.10.3 Captured waveform

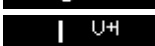
Captured waveform can be viewed from the Memory list menu. Following views are available for the waveform record:

- U,I,f meter table screen,
- U,I,f scope screen,
- U,I,f RMS trend screen.

U,I,f - METER		R: 23	L1	12:33
	U	I		
RMS	194.6 V	1768 A		
THD	0.7 %	0.0 %		
CF	1.67	1.41		
PEAK	325.0 V	2500 A		
MAX 1/2	230.3 V	1771 A		
MIN 1/2	0.0 V	0.0 A		
f	49.984 Hz			
		1 2 3 N \curvearrowright Δ	SCOPE	









Figure 3.35: Captured waveform meter screen

Table 3.44: Instrument screen symbols and abbreviations – METER

L1 L2 L3	
L12 L23 L31	Show currently displayed channel.
N \curvearrowright Δ	
R: 23	Show record number in MEMORY LIST.
20:45	Current instrument time.
RMS	True effective value $U_{Rms(10)}$ and $I_{Rms(10)}$.

THD	Total harmonic distortion THD _U and THD _I .
CF	Crest factor Cf _U and Cf _I .
PEAK	Peak value U _{PK} and I _{PK} .
MAX 1/2	Maximal U _{Rms(1/2)} voltage U _{Rms(1/2)Max} and maximal I _{1/2Rms} current, I _{1/2RmsMax} measured from last RESET (key: F2).
MIN 1/2	Minimal U _{Rms(1/2)} voltage U _{Rms(1/2)Min} and minimal I _{1/2Rms} current I _{1/2RmsMin} , measured from last RESET (key: F2).
f	Frequency on reference channel.

Table 3.45: Keys functions - METER

		Show measurements for phase L1
		Show measurements for phase L2
		Show measurements for phase L3
		Show measurements for neutral channel
		Summary of all phases measurements
		Show phase-to-phase voltages measurements
	METER	Switch to METER view.
	SCOPE	Switch to SCOPE view
	TREND	Switch to TREND view (available only during recording)
		Return to the “WAVEFORM RECORDER” setup screen.

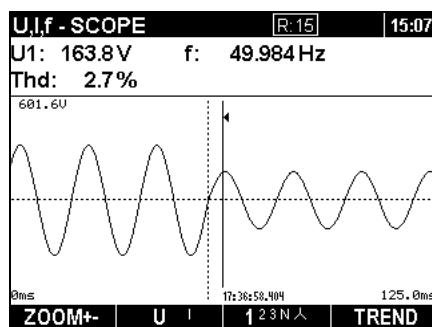



Figure 3.36: Captured waveform scope screen

Table 3.46: Instrument screen symbols and abbreviations - SCOPE

	Current instrument time.
	Show record number in MEMORY LIST.
U1, U2, U3, Un, U12, U23, U31	True effective value of voltage – U _{Rms(10)} .
I1, I2, I3, In	True effective value of current – I _{Rms(10)} .
Thd	Total harmonic distortion THD _U and THD _I .
f	Frequency on reference channel.
0ms 125.0ms	Time scale at beginning and the end of the scope screen

601.6U 2040A	Voltage/current scale and the top/bottom of the scope screen
17:36:58.408	Cursor position time.

Table 3.47: Keys functions - SCOPE

F1	ZOOM+/- ZOOM+	Zoom in. Zoom out.
F2	U I I UH U+I UM U/I U	Select between the following signals: Show voltage waveform; Show current waveform; Show voltage and current waveform in single graph; Show voltage and current waveform in two separate graph.
F3	1 2 3 N A Δ 1 2 3 N A Δ 1 2 3 N A Δ 1 2 3 N A Δ 1 2 3 N A Δ 1 2 3 N A Δ	Show measurement for phase L1 Show measurement for phase L2 Show measurement for phase L3 Show measurement for neutral channel Summary of all phases measurements Show phase-to-phase voltages measurements
F4	TREND	Switch to RMS TREND view.
ENTER		Select which waveform to zoom vertically (only in U/I or U+I graphs).
↑ ↓		Set vertical zoom.
← →		Move cursor position.
ESC		Return to the “WAVEFORM RECORDER” setup screen.

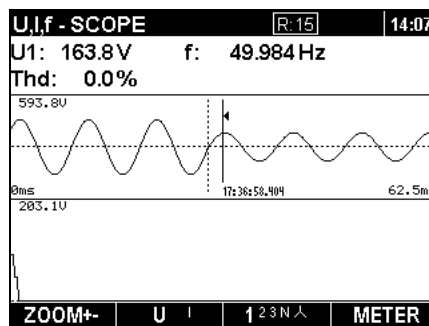

Figure 3.37: Captured waveform RMS trend screen

Table 3.48: Instrument screen symbols and abbreviations - TREND

	Current recorder status;
	<ul style="list-style-type: none"> Instrument is recording; Instrument is busy (retrieving data from memory);
	<ul style="list-style-type: none"> Instrument is not in recording mode.
20:45	Current instrument time.
U1, U2, U3, UN, U12, U23, U31	True effective value of voltage – $U_{Rms(10)}$.
I1, I2, I3, IN	True effective value of current – $I_{Rms(10)}$.
Thd	Total harmonic distortion THD_U and THD_I .
f	Frequency on reference channel.
17:36:58.408	Cursor position time.

Table 3.49: Keys functions - TREND

	ZOOM+ ZOOM-	Zoom in. Zoom out.
	U I I U	Select between the following signals: Show voltage waveform; Show current waveform.
	1 2 3 N 1 2 3 N 1 2 3 N 1 2 3 N 1 2 3 N	Select between phase, neutral, all-phases and view: Show trend for phase L1 Show trend for phase L2 Show trend for phase L3 Show trend for neutral channel Summary of all phases trends
	METER	Switch to tabular METER view.
		Toggle cursor assignment between waveform scope and RMS trend.
		Set vertical zoom (Only if cursor assigned to waveform scope).
		Move cursor position.
		Return to the “WAVEFORM RECORDER” setup screen.

3.11 Inrush / Fast recorder

High inrush currents of motors can cause breakers to trip or fuses to open. Maximum expected current during the inrush might be 6 to 14 times greater than the full load current of the motor.

This function is based on a principle of logging data exceeding the set (trigger) level with positive, negative or both slopes on a current or voltage input.

When trigger occurs, data capturing begins. Instrument record until **Duration** time has been reached. According to the **Pretrigger length** parameter, instrument also records data before trigger has occurred.

3.11.1 Setup

By selecting the "INRUSH/FAST RECORDER" from the "RECORDERS" menu screen the "INRUSH Recorder Setup" screen is shown (see figure below).

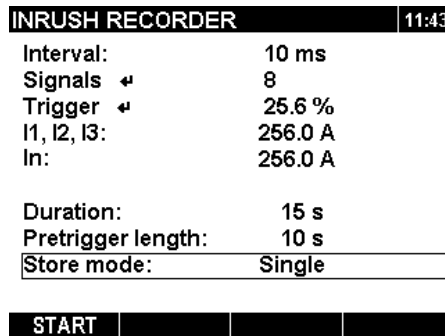







Figure 3.38: Inrush recorder setup screen

Table 3.50: Instrument screen symbols and abbreviations

Interval	Logging interval setup (from 10 ms to 200 ms).												
Signals	Select logging signals: <div style="text-align: center;"> <table border="1"> <tr><th colspan="4">SIGNALS</th></tr> <tr><td>U1</td><td>U2</td><td>U3</td><td>Un</td></tr> <tr><td>I1</td><td>I2</td><td>I3</td><td>In</td></tr> </table> </div>	SIGNALS				U1	U2	U3	Un	I1	I2	I3	In
SIGNALS													
U1	U2	U3	Un										
I1	I2	I3	In										
Trigger	Trigger set up: <ul style="list-style-type: none"> • Current input for trigger source • Trigger level at which inrush logging will start • Trigger slope direction (FALL, RISE, BOTH). <div style="display: flex; justify-content: space-around;"> <div style="border: 1px solid black; padding: 5px;"> <p style="text-align: center; margin: 0;">TRIGGER</p> <table border="1" style="margin: 0 auto;"> <tr><td>I1</td><td>I2</td><td>I3</td><td>In</td></tr> </table> <p style="margin: 5px 0;">Level: 25.6 % I1, I2, I3: 256.0 A IN: 256.0 A Slope: FALL</p> </div> <div style="border: 1px solid black; padding: 5px;"> <p style="text-align: center; margin: 0;">TRIGGER</p> <table border="1" style="margin: 0 auto;"> <tr><td>U1</td><td>U2</td><td>U3</td><td>Un</td></tr> </table> <p style="margin: 5px 0;">Level: 27.8 % U1, U2, U3: 83.4 V UN: 83.4 V Slope: FALL</p> </div> </div>	I1	I2	I3	In	U1	U2	U3	Un				
I1	I2	I3	In										
U1	U2	U3	Un										
Duration	Total logging time in seconds.												
Pretrigger length	Adjusting length of the logging part prior to trigger condition occurrence.												
Store mode	Store mode setup: <ul style="list-style-type: none"> • Single – single inrush logging; • Continuous – consecutive inrush logging until user stop or instrument runs out of storage memory. Every consecutive inrush logging will be treated as a separate record. 												

Table 3.51: Keys functions

	START	Start the inrush logger.
	U I	Toggle between voltage and current trigger signal selection (Only in "Trigger" dialog window).
	I U	Note: If user forces inrush logging to stop no data is recorded. Logging of data only occurs when trigger is activated.
	SET	Toggle between ON (selected) and OFF (deselected) for recording in SIGNAL dialog. Toggle between ON (selected) and OFF (deselected) for triggering in TRIGGER dialog.
		Select "Interval", "Signals", "Trigger", "Duration", "Pretregger length or "Store mode" on the "INRUSH LOGGER" setup screen. If in "Signals" dialog, scroll between voltage and current values. If in "Trigger" dialog, scroll between trigger source, trigger level and trigger slope.
		If "Interval" is selected, change interval period. If "Signals" dialog is open, scroll through all channels. If "Trigger" dialog is open, scroll through trigger sources / change trigger level / change trigger slope.
		Open SIGNALS dialog box (if "Signals" is selected). In this dialog box the individual signals can be selected for logging. Open TRIGGER dialog box (if "Trigger" is selected). In this dialog box the trigger channels can be selected, level and slope of the trigger signal can be defined for triggering.
		Return to the "RECORDERS" menu screen or close the "Signals" or "Trigger" dialog box (if dialog box is open).

3.11.2 Capturing inrush

Following screen opens when a user starts the inrush logger.

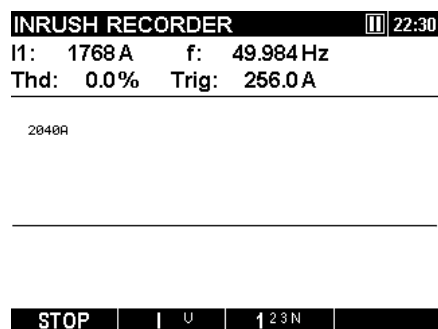







Figure 3.39: Inrush logger capture screen

Table 3.52: Instrument screen symbols and abbreviations

Current recorder status:	
	• Instrument is waiting (trigger conditions are not met);
	• Instrument is recording (beep indicates that trigger limit has been reached).

20:45	Current instrument time.
U1..UN	True effective voltage value $U_{Rms(10)}$.
I1..IN	True effective current value $I_{Rms(10)}$.
Thd	Total harmonic distortion THD_U or THD_I .
f	Frequency on reference channel.
Trig	Settled trigger value.
230.4 V 2040 A	Represent current (voltage) value at the top of the graph (horizontal line between graph and table values).

Table 3.53: Keys function

	STOP	Stop the inrush logger. Note: If user forces inrush logging to stop no data is recorded. Logging of data only occurs when trigger is activated.
	U I I U	Toggle between voltage and current channel. Show $U_{rms(1/2)}$ voltage trend graph. Show $I_{1/2Rms}$ current trend graph.
	1 2 3 N 1 2 3 N 1 2 3 N 1 2 3 N	Select between phases. Show graph and parameters for phase L1. Show graph and parameters for phase L2. Show graph and parameters for phase L3. Show graph and parameters for neutral channel.
	ESC	Return to the "RECORDERS" menu screen.

3.11.3 Captured inrush

Captured inrush can be viewed from the Memory list menu. The recorded signal trace can be scrolled through and reviewed with a cursor. Data are displayed in graphical (logger histogram) and in numeric (interval data) form.

The following values can be displayed in the data fields:

- Minimum, maximum and average data of the interval selected with the cursor,
- Time relative to the trigger-event time.

Complete trace of selected signal can be viewed on the histogram. The cursor is positioned to the selected interval and can be scrolled over all intervals. All results are saved to the instrument memory. Signals are auto scaled.

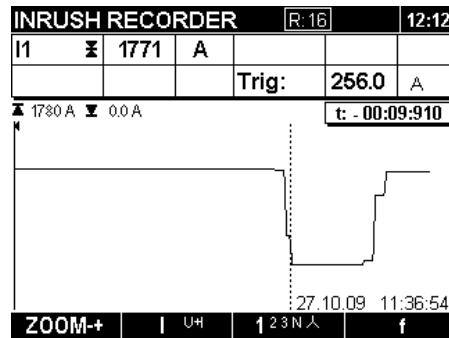



Figure 3.40: Captured inrush

Table 3.54: Instrument screen symbols and abbreviations

	Instrument loading data from memory.
R:16	Show record number in MEMORY LIST.
20:45	Current instrument time.
	Indicate position of the cursor at the graph.
U1..UN	True effective voltage value $U_{Rms(10)}$ at cursor point.
I1..IN	True effective current value $I_{Rms(10)}$ at cursor point.
Trig	Settled trigger value.
230.6 V 225.3 V	Maximal and minimal (current/voltage) value on graph.
892.1 A 3.4 A	
01.01.00 00:46:31	Date and time at the current cursor position.
t: -00:00:630	Time relative to the trigger event occurrence.

Table 3.55: Keys function

	ZOOM+	Zoom in.
	ZOOM-	Zoom out.
	U I	Toggle between voltage and current channel: Show $U_{rms(1/2)}$ voltage trend graph;
	I UH	Show $I_{1/2Rms}$ current trend graph;
	U+I UH	Show voltage $U_{rms(1/2)}$ and current $I_{1/2Rms}$ trend in single graph;
	U/I U	Show voltage $U_{rms(1/2)}$ and current $I_{1/2Rms}$ trend in two separate graphs.
		Select between phase, neutral, all-phases and view:
	1 2 3 N	Show trend for phase L1
	1 2 3 N	Show trend for phase L2
	1 2 3 N	Show trend for phase L3
	1 2 3 N	Show trend for neutral channel
	1 2 3 N	Summary of all phases trends
	f	Show frequency trend.
	TREND	Show voltage/current trend
		Select between scopes.

 Scroll the cursor along logged data.

 Return to the “INRUSH LOGGER” setup screen.

3.12 Transients recorder

Transient is a term for **short, highly damped** momentary voltage or current disturbance. A transient recording is recording with the 25 kHz sampling rate. The principle of measurement is similar to waveform recording, but with a 10 times higher sampling rate (1024 samples per period). In contrary to inrush or waveform recording, where recording is triggered based on rms values, trigger in transient recorder is based on sample value.

3.12.1 Setup

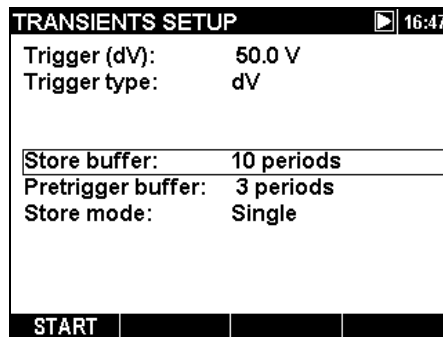

Figure 3.41: Transients setup screen

Table 3.56: Instrument screen symbols and abbreviations







Trigger (dV)	Trigger value: 
Trigger type	Trigger type set up: <ul style="list-style-type: none"> • Manual trigger – user can manually generate a trigger event. • dV – voltage rate of change that triggers transients recorder.
Store buffer	Number of signal periods to be recorded.
Pretrigger buffer	Number of signal periods that user wants to record prior to the trigger condition occurrence.
Store mode	Store mode setup: <ul style="list-style-type: none"> • Single – single transient recording • Continuous – consecutive transients recording until user stop or instrument runs out of storage memory. Every consecutive transients recording will be treated as a separate record.

Table 3.57: Keys functions

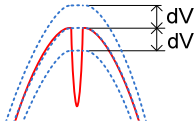
	START	Start transient recorder.
	STOP	Stop transient recorder. Note: If user forces transients recorder to stop no data is recorded. Data recording occurs only when trigger is activated.
	TRIG	Manually generate trigger condition (Active only if Manual trigger selected and recording in progress).
	SCOPE	Switch to SCOPE view (Active only if recording in progress).
		Move cursor position.
		Select parameter / change value.
		Return to the “RECORDERS” menu screen or “MEMORY LIST” screen.

3.12.2 Capturing transients

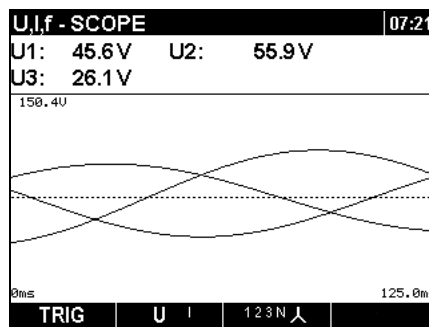

Figure 3.42: Transients capture screen

Table 3.58: Instrument screen symbols and abbreviations



















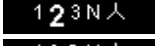
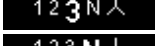
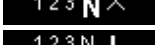
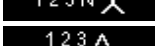

	Current instrument status:
	• Instrument is waiting for trigger to happen;
	• Instrument is recording (beep indicates that trigger limit has been reached);
	• Instrument is busy (saving data to memory).
20:45	Current instrument time.
Up	True effective value of phase voltage:
p: [1..3, N]	$U_{1Rms}, U_{2Rms}, U_{3Rms}, U_{NRms}$
Upg	True effective value of phase-to-phase (line) voltage:
p,g: [1, 2, 3]	$U_{12Rms}, U_{23Rms}, U_{31Rms}$
Ip	True effective value of current:
p: [1..3, N]	$I_{1Rms}, I_{2Rms}, I_{3Rms}, I_{NRms}$
0ms 125.0ms	Time scale at beginning and the end of the scope screen
150.4U	Voltage scale and the top/bottom of the scope screen

Table 3.59: Keys function

		Manually generate trigger condition (Active only if Manual trigger selected and recording is in progress).
	   	Select which waveforms to show: Show voltage waveform; Show current waveform; Show voltage and current waveform (single mode); Show voltage and current waveform (dual mode).
	     	Select between phase, neutral, all-phases and line view: <ul style="list-style-type: none"> • Show waveforms for phase L1; • Show waveforms for phase L2; • Show waveforms for phase L3; • Show waveforms for neutral channel; • Summary of all phases waveforms; • Show phase-to-phase voltages.
		Select which waveform to zoom (only in U/I or U+I).
		Set vertical zoom.
		Set horizontal zoom.
		Return to the “TRANSIENTS SETUP” screen.

3.12.3 Captured transients

Captured transients records can be viewed from the Memory list through two different screens:

- U, I, f scope screen and
- U, I, f RMS trend screen.

Trigger occurrence is marked with the dotted line on both screens.

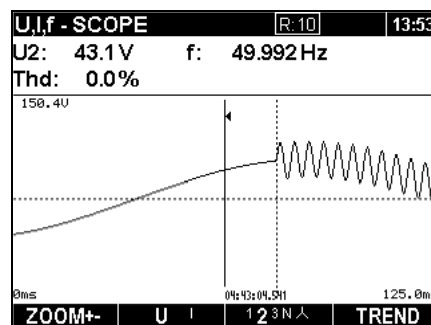

Figure 3.43: Captured transients scope screen

Table 3.60: Instrument screen symbols and abbreviations

	Current instrument time.
	Show record number in MEMORY LIST.
U1, U2, U3, UN, U12, U23, U31	True effective value of voltage – $U_{Rms(10)}$.
I1, I2, I3, IN	True effective value of current – $I_{Rms(10)}$.
THDp	Total distortion of phase voltage: THD _{U1} , THD _{U2} , THD _{U3} , THD _{UN}
THDpg p,g: [1, 2, 3]	Total distortion of phase to phase voltage: THD _{U12} , THD _{U23} , THD _{U31}
f	Frequency on reference channel.
	Time at cursor position.
	Time scale at beginning and the end of the scope screen
	Voltage scale and the top/bottom of the scope screen

Table 3.61: Keys function

	 	Zoom in. Zoom out.
	 	Select between the following signals: Show voltage waveform. Show current waveform. Show voltage and current waveform in single graph. Show voltage and current waveform in two separate graphs.
		Select between single phase, neutral and all-phases waveform graphs.
	 	Select between phase, neutral, all-phases and view: Show transient for phase L1 Show transient for phase L2 Show transient for phase L3 Show transient for neutral channel Summary of all phases trends
		Switch to RMS TREND view.
		Select which waveform to zoom vertically (only in U/I or U+I graphs).
		Set vertical zoom.
		Move cursor position.
		Return to the “TRANSIENTS SETUP” screen.

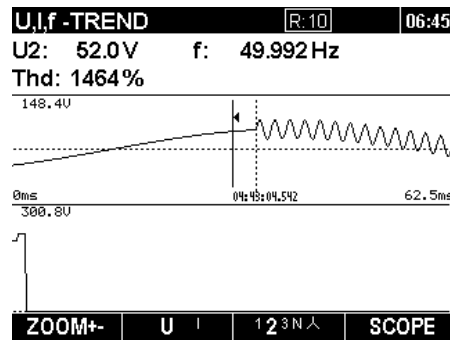





Figure 3.44: Captured transients RMS trend screen

Table 3.62: Instrument screen symbols and abbreviations

20:45	Current instrument time.
R:10	Show record number in MEMORY LIST.
U1, U2, U3, UN, U12, U23, U31	True effective value of voltage – $U_{Rms(10)}$.
I1, I2, I3, IN	True effective value of current – $I_{Rms(10)}$.
THDp	Total distortion of phase voltage: THD _{U1} , THD _{U2} , THD _{U3} , THD _{UN}
THDpg p,g: [1, 2, 3]	Total distortion of phase to phase voltage: THD _{U12} , THD _{U23} , THD _{U31}
f	Frequency on reference channel.
04:43:04.541	Time at cursor position.
0ms 125.0ms	Time scale at beginning and the end of the scope screen
150.4U 2040A	Voltage scale and the top/bottom of the scope screen

Table 3.63: Keys function

F1	ZOOM+/-	Zoom in.
	ZOOM+	Zoom out.
F2	U I	Select between the following signals: Show voltage waveform;
	I U	Show current waveform ;
F3		Select between phase, neutral, all-phases and view:
	1 2 3 N	Show transient for phase L1
	1 2 3 N	Show transient for phase L2
	1 2 3 N	Show transient for phase L3
	1 2 3 N	Show transient for neutral channel
	1 2 3 N	Summary of all phases trends
F4	SCOPE	Switch to SCOPE view.
ENTER		Toggle cursor assignment between transients scope and RMS trend.

	Set vertical zoom (Only if cursor assigned to transients scope).
	Move cursor position.
	Return to the "TRANSIENTS SETUP" screen.

3.13 Events table

In this table captured voltage dips, swells and interrupts are shown. Note that events appear in the table after finishing, when voltage return to the normal value. All events can be grouped or separated by phase. This is toggled by pressing function key F1.

Group view

In this view voltage event are grouped according to IEC 61000-4-30 (see section 5.1.12 for details). Table where events are summarized is shown bellow. Each line in table represents one event, described by event number, event start time and duration and level. Additionally in colon "T" event characteristics are shown (see table bellow for details).

VOLTAGE EVENTS ▶ 01:48				
Date: 01.01.00				
No:	L Start:	T	Level:	Duration:
600	00:00:03:539	IDS	233.9V	1.856 hrs
583	00:00:03:532	IDS	231.9V	14.833 min
556	00:00:03:537	S	233.8V	53.158 sec
542	00:00:03:553	S	235.2V	3.129 hrs
520	00:24:47:589	S	274.8V	3.530 sec
516	00:24:03:056	ID	1.4V	43.543 sec
509	00:23:02:225	ID	0.3V	1.300 sec
Σ PH				STAT

Figure 3.45: Voltage events in group view screen

By pressing "Enter" on particular events we can examine its details. Event is split on phase events sorted by start time. Colon "T" shows transition from one event state to another (see table bellow for details).

VOLTAGE EVENTS ◻ 01:48				
Date: 01.01.00				
No:	L Start:	T	Level:	Duration:
553	1	00:00:03:537	N->S	232.4V
554	2	00:00:03:537	N->S	233.8V
555	3	00:00:03:537	N->S	233.7V
				53.158 sec
				3.129 hrs
				3.530 sec

Figure 3.46: Voltage events group view screen

Table 3.64: Instrument screen symbols and abbreviations













	Current recorder status: RECORDER is active
	RECORDER is busy (retrieving data from memory)
	RECORDER is not active
Date	Date when selected event has occurred
No.	Unified event number (ID)
L	Indicate phase or phase-to-phase voltage where event has occurred: 1 – event on phase U_1 2 – event on phase U_2 3 – event on phase U_3 12 – event on voltage U_{12} 23 – event on voltage U_{23} 31 – event on voltage U_{31} Note: this indication is shown only in event details, since one grouped event can have many phase events.
Start	Event start time (when first $U_{Rms(1/2)}$ value cross threshold.
T	Indicates type of event or transition: D – Dip I – Interrupt S – Swell N → D Transition from normal state to dip N → S Transition from normal state to swell D → I Transition from dip to interrupt
Level	Minimal or maximal value in event U_{Dip} , U_{Int} , U_{Swell}
Duration	Event duration.

Table 3.65: Keys functions

		Group view is shown. Press to switch on “PHASE” view.																																													
		Phase view is shown. Press to switch on “GROUP” view.																																													
		Show event summary (by types and phases):																																													
		<table border="1"> <tr> <td colspan="4">VOLTAGE EVENTS</td> <td>01:11</td> </tr> <tr> <td></td> <td>L1</td> <td>L2</td> <td>L3</td> <td></td> </tr> <tr> <td>U</td> <td>226.6</td> <td>227.7</td> <td>228.4V</td> <td></td> </tr> <tr> <td colspan="5">EVENTS</td> </tr> <tr> <td>Swell:</td> <td>6</td> <td>5</td> <td>7</td> <td></td> </tr> <tr> <td>Dip:</td> <td>3</td> <td>1</td> <td>2</td> <td></td> </tr> <tr> <td>Inter.:</td> <td>0</td> <td>0</td> <td>0</td> <td></td> </tr> <tr> <td>Start:</td> <td>17:17:14</td> <td colspan="2">01.01.08</td> <td></td> </tr> <tr> <td>Curr.:</td> <td>01:11:12</td> <td colspan="2">03.02.08</td> <td></td> </tr> </table>	VOLTAGE EVENTS				01:11		L1	L2	L3		U	226.6	227.7	228.4V		EVENTS					Swell:	6	5	7		Dip:	3	1	2		Inter.:	0	0	0		Start:	17:17:14	01.01.08			Curr.:	01:11:12	03.02.08		
VOLTAGE EVENTS				01:11																																											
	L1	L2	L3																																												
U	226.6	227.7	228.4V																																												
EVENTS																																															
Swell:	6	5	7																																												
Dip:	3	1	2																																												
Inter.:	0	0	0																																												
Start:	17:17:14	01.01.08																																													
Curr.:	01:11:12	03.02.08																																													
																																															
		Back to Group view.																																													
		Show details about the selected event.																																													

VOLTAGE EVENTS					01:48
Date: 01.01.00					
No:	L	Start:	T	Level:	Duration:
553	1	00:00:03:537	N->S	232.4V	53.158 sec
554	2	00:00:03:537	N->S	233.8V	3.129 hrs
555	3	00:00:03:537	N->S	233.7V	3.530 sec

 Select event.

 Exit from detailed view of an event.
 Back to the "RECORDERS" menu screen.

Phase view





In this view voltage events are separated by phases. This is convenient view for troubleshooting. Additionally user can use filters in order to observe only particular type of event on a specific phase. Captured events are shown in a table, where each line contains one phase event. Each event has an event number, event start time, duration and level. Additionally in colon "T" type of event is shown (see table below for details).

VOLTAGE EVENTS					01:05
Date: 01.01.00					
No:	L	Start:	T	Level:	Duration:
599	3	00:00:23:845	S	232.5V	-- -- --
595	2	00:00:03:539	S	233.9V	-- -- --
594	1	00:00:03:539	S	232.3V	-- -- --
598	3	00:00:22:165	D	37.4V	1.680 sec
597	3	00:00:22:165	I	0.3V	1.670 sec
596	3	00:00:03:539	S	229.6V	18.626 sec
571	3	00:00:40:595	S	231.4V	-- -- --
568	2	00:00:03:532	S	231.9V	-- -- --
582	1	00:00:45:037	S	229.7V	-- -- --
573	1	00:00:43:456	D	11.8V	1.581 sec
PH	Σ	Σ	DIP	1 2 3 Σ	STAT

Figure 3.47: Voltage events screens













You can also see details of each individual voltage event and statistics of all events. Statistics show count registers for each individual event type by phase.

Table 3.66: Instrument screen symbols and abbreviations

	Current recorder status
	RECORDER is active
	RECORDER is busy (retrieving data from memory)
	RECORDER is not active
Date	Date when selected event has occurred
No.	Unified event number (ID)
L	Indicate phase or phase-to-phase voltage where event has occurred: 1 – event on phase U ₁ 2 – event on phase U ₂

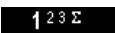
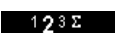
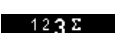
	3 – event on phase U_3 12 – event on voltage U_{12} 23 – event on voltage U_{23} 31 – event on voltage U_{31}
Start	Event start time (when first $U_{Rms(1/2)}$) value cross threshold.
T	Indicates type of event or transition: D – Dip I – Interrupt S – Swell
Level	Minimal or maximal value in event U_{Dip} , U_{Int} , U_{Swell}
Duration	Event duration.

Table 3.67: Keys function

		Group view is shown. Press to switch on “PHASE” view.																																												
		Phase view is shown. Press to switch on “GROUP” view.																																												
	Filter events by type:																																													
		Show all events																																												
		Show dips only																																												
		Show interrupts only																																												
	Filter events by phase:																																													
		Show only events on phase 1																																												
		Show only events on phase 2																																												
		Show only events on phase 3																																												
		Show event summary (by types and phases):																																												
	<table border="1" data-bbox="735 1431 1169 1753"> <thead> <tr> <th colspan="4">VOLTAGE EVENTS</th> <th>01:11</th> </tr> <tr> <th></th> <th>L1</th> <th>L2</th> <th>L3</th> <th></th> </tr> </thead> <tbody> <tr> <td>U</td> <td>226.6</td> <td>227.7</td> <td>228.4V</td> <td></td> </tr> <tr> <th colspan="5">EVENTS</th> </tr> <tr> <td>Swell:</td> <td>6</td> <td>5</td> <td>7</td> <td></td> </tr> <tr> <td>Dip:</td> <td>3</td> <td>1</td> <td>2</td> <td></td> </tr> <tr> <td>Inter.:</td> <td>0</td> <td>0</td> <td>0</td> <td></td> </tr> <tr> <td>Start:</td> <td>17:17:14</td> <td colspan="2">03.02.38</td> <td></td> </tr> <tr> <td>Curr.:</td> <td>01:11:12</td> <td colspan="2">01.01.00</td> <td></td> </tr> </tbody> </table>		VOLTAGE EVENTS				01:11		L1	L2	L3		U	226.6	227.7	228.4V		EVENTS					Swell:	6	5	7		Dip:	3	1	2		Inter.:	0	0	0		Start:	17:17:14	03.02.38			Curr.:	01:11:12	01.01.00	
VOLTAGE EVENTS				01:11																																										
	L1	L2	L3																																											
U	226.6	227.7	228.4V																																											
EVENTS																																														
Swell:	6	5	7																																											
Dip:	3	1	2																																											
Inter.:	0	0	0																																											
Start:	17:17:14	03.02.38																																												
Curr.:	01:11:12	01.01.00																																												
	Back to Group view.																																													
	Show details about the selected event:																																													

VOLTAGE EVENTS
01:06

Dip:
 Min: L3 37.4V
 Start: 00:00:22:165 01.01.00
 End: 00:00:23:845 01.01.00
 Duration: 00:00:00:01:680

Select event.

ESC

Exit from detailed view of an event.
Back to the "RECORDER" menu screen.

3.14 Alarms table

This menu shows list of alarms which went off. Alarms are displayed in a table, where each row represents an alarm. Each alarm is associated with a start time, phase, type, slope, min/max value and duration (see 3.16.3 for alarm setup and 5.1.13 for alarm measurement details).

ALARMS LIST						02:06
Date: 01.01.00						
Start:	L	T	Slope:	Min/Max:	Duration:	
01:56:59:921	2	pstm	RISE	0.664	59.997 sec	
01:47:59:785	2	pstm	RISE	0.791	3. 0 min	
01:11:59:863	2	pstm	RISE	0.698	1. 0 min	
01:04:59:930	2	pstm	RISE	0.728	1.983 min	
01:01:59:823	2	pstm	RISE	0.795	1. 0 min	
00:59:59:950	2	pstm	RISE	0.666	59.834 sec	
00:55:59:834	2	pstm	RISE	0.767	1. 0 min	
00:44:29:890	1	U	FALL	230.0V	401 ms	
00:44:26:690	1	U	RISE	230.1V	400 ms	
00:44:25:890	1	U	RISE	230.1V	400 ms	
	Σ	U _f		1 2 3 N T Σ		























Figure 3.48: Alarms list screen

Table 3.68: Instrument screen symbols and abbreviations

	Current recorder status:
	RECORDER is active
	RECORDER is busy (retrieving data from memory)
	RECORDER is not active
Date	Date when selected alarm has occurred
Start	Selected alarm start time (when first U_{RMS} value cross threshold)
L	Indicate phase or phase-to-phase voltage where event has occurred: 1 – alarm on phase L ₁ 2 – alarm on phase L ₂ 3 – alarm on phase L ₃ 12 – alarm on line L ₁₂ 23 – alarm on line L ₂₃ 31 – alarm on line L ₃₁

Slope	Indicates alarms transition: <ul style="list-style-type: none"> • Rise – parameter has over-crossed threshold • Fall – parameter has under-crossed threshold
Level	Minimal or maximal parameter value during alarm occurrence
Duration	Alarm duration.

Table 3.69: Keys function

		Filter alarms according to the following parameters:
		All alarms
		Voltage alarms
		Power alarms
		Flicker alarms
		Unbalance alarms
		
		Harmonics alarms
		
		Interharmonics alarms
		Signalling alarms
		Filter alarms according to phase on which they occurred:
		Show only alarms on phase 1
		Show only alarms on phase 2
		Show only alarms on phase 3
		Show only alarms on neutral channel
	Show only alarms on channels which are not channel dependent	
	Show all alarms	
		Show active alarm list. List includes alarms which has started, but not finished yet. Notation used in this table is same as described in this section.
		Select an alarm
		Exit from the “Active alarms list” screen. Back to the “RECORDER” menu screen.

3.15 Memory List

Using this menu user can view and browse through saved records. By entering this menu, information about last record is shown.

MEMORY LIST		00:19
Record No:		7
Type:	Inrush logging	
Signals:		6
Start:	01:47:13	01.01.00
End:	01:47:16	01.01.00
Size (kB):		4
Saved Records:		7
CLEAR		

Figure 3.49: Memory list screen

Table 3.70: Instrument screen symbols and abbreviations









	Current recorder status
	RECORDER is active
	RECORDER is busy (retrieving data from memory)
	RECORDER is not active
	Current instrument time
Record No	Selected record number, for which details are shown.
Type	Indicate type of record, which can be one of following: <ul style="list-style-type: none"> • inrush logging, • waveform snapshot, • transient recording, • waveform recording, • general recording.
Signals	Number of recorded signals.
Start	Record start time.
End	Record stop time.
Size (kB)	Record size in kilobytes (kB).
Saved records	Total number of records in memory.

Table 3.71: Keys functions

	VIEW	View details of currently selected record.
	CLEAR	Clear the last record. In order to clear complete memory, delete records one by one.
	CLRALL	Clear all saved records.
		Browse through records (next or previous record).
		Returns to the “RECORDERS” menu screen.

3.15.1 Record

This type of record is made by RECORDER. Record front page is similar to the RECORDER menu, as shown on figure below.



RECORDER		R:10	18:23
Record Type:	Record		
Interval:	1s		
Signals	173		
Duration	00 h 05 m 12 s		
Include active events	0		
Include active alarms	0		
Start time	18:13:10 26.10.09		
VIEW			

Figure 3.50: Front page of Record in MEMORY LIST menu

Table 3.72: Recorder settings description

20:45	Current instrument time.
R:10	Show record number in MEMORY LIST.
Record type: RECORD	Indicator that record type is made by GENERAL RECORDER.
Interval: 1s	Show interval used for GENERAL RECORDER.
Signals: 173 (max, min, avg)	Show number of signals in record.
Memory type: Linear	Show how memory is organized.
Duration: 00h 05m 12s	Show duration of record.
Include active events: 4	Show number of captured events.
Include active alarms: 0	Show number of captured alarms.
Start time	Show record start time.

Table 3.73: Keys function

	Switch to the CHANNELS SETUP menu screen.
 VIEW	User can observe particular signal group by pressing on  key (VIEW).

CHANNELS SETUP		R: 6	15:25
U, I, f	On		
Power & Energy	Off		
Flickers	On		
Sym	On		
Harmonics	On		
Interharmonics	Off		

VIEW			
-------------	--	--	--



Select parameter (only in CHANNELS SETUP menu).



Back to the previous menu.

By pressing **F1** **VIEW** in CHANNELS SETUP menu TREND screen will appear. TREND type depends on the position of a cursor. Typical screen is shown on figure below.

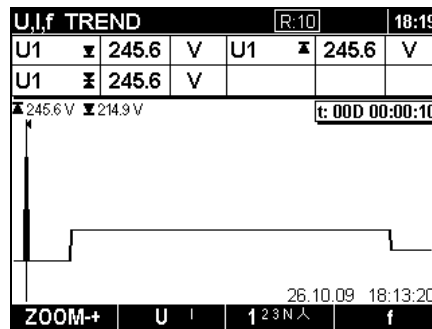

Figure 3.51: Viewing recorder U,I,f TREND data

Table 3.74: Instrument screen symbols and abbreviations

R:8	Show record number in MEMORY LIST.
20:45	Current instrument time.
↑	Indicate position of the cursor at the graph.
Up, Upg:	Maximal (▲), average (⊠) and minimal (▼) recorded value of phase voltage U_{pRms} or line voltage U_{pgRms} for time interval selected by cursor.
Ip:	Maximal (▲), average (⊠) and minimal (▼) recorded value of current I_{pRms} for time interval selected by cursor.
t: 00D 00:13:23	Time position of cursor regarding to the record start time.
▲ 230.6 V ▼ 225.3 V	Maximal and minimal Up/Upg on displayed graph;
▲ 947.1 A ▼ 0.0 A	Maximal and minimal Ip on displayed graph.
26.10.09 18:13:20	Time clock at position of cursor.

Table 3.75: Keys functions

F1	ZOOM+ ZOOM-	Zoom in. Zoom out.
F2	U I I UH U+I UM U/I U	Select between the following options: Show voltage trend; Show current trend; Show voltage and current trend in single graph; Show voltage and current trend in two separate graphs.
F3	1 2 3 N 1 2 3 N 1 2 3 N 1 2 3 N 1 2 3 N	Select between phase, neutral, all-phases and view: Show trend for phase L1 Show trend for phase L2 Show trend for phase L3 Show trend for neutral channel Summary of all phases trends
F4	f	Show frequency trend.
ENTER		Select which waveform to zoom (only in U/I or U+I trends).
		Scroll the cursor along logged data.
ESC		Return to the “CHANNELS SETUP” menu screen.

Note: Other recorded data (power, harmonics, etc.) has similar manipulation principle as described in table above.

3.15.2 Waveform snapshot

This type of record can be made by using Hold → Save procedure. Its front page is similar to the screen where it was recorded, as shown on figure bellow.

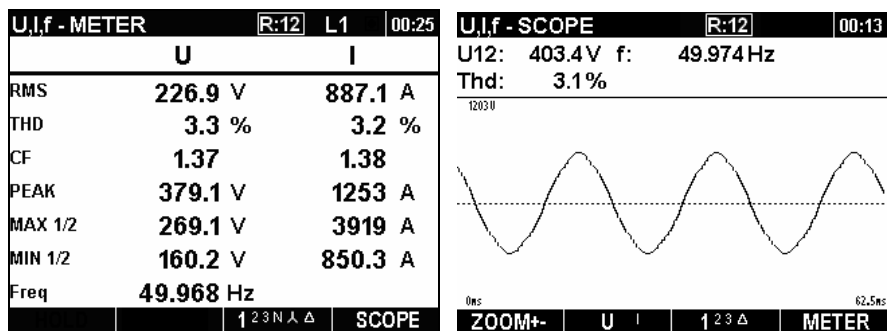

Figure 3.52: Front page of Normal record in MEMORY LIST menu

For screen symbols and key functions see corresponding METER, SCOPE, BAR graph, PHASE DIAG. description given in appropriate sections (U, I, f; Power, etc..).

3.15.3 Waveform record

This type of record is made by Waveform recorder. For details regarding manipulation and data observing see section Captured waveform 3.10.3

3.15.4 Inrush/Fast logger

This type of record is made by Inrush logger. For details regarding manipulation and data observing see section 3.11.3.

3.15.5 Transients record

This type of record is made by Transient recorder. For details regarding manipulation and data observing see section 3.12.3.

3.16 Measurement Setup menu

From the “MEASUREMENT SETUP” menu measurement parameters can be reviewed, configured and saved.

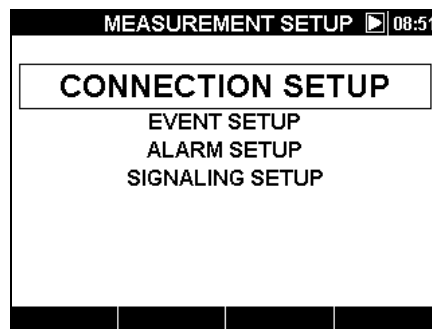





Figure 3.53: MEASUREMENT SETUP menu

Table 3.76: Description of setup options

Connection setup	Setup measurement parameters.
Event setup	Setup event parameters.
Alarm setup	Setup alarm parameters.
Signalling setup	Setup signalling parameters

Table 3.77: Keys function

	Select function from the “SETUP” menu.
	Enter the selected item.
	Back to the “MAIN MENU” screen.

3.16.1 Connection setup

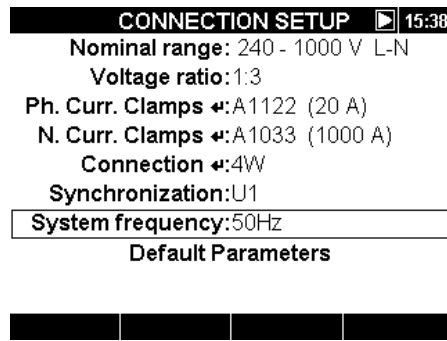
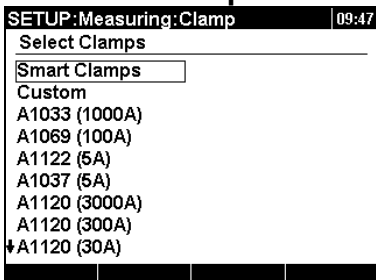

Figure 3.54: "CONNECTION SETUP" screen

Table 3.78: Description of Connection setup

Nominal range	<p>Nominal voltage range. Select voltage range according to the nominal network voltage.</p> <table border="1" data-bbox="655 842 1273 1014"> <thead> <tr> <th>1W and 4W</th> <th>3W</th> </tr> </thead> <tbody> <tr> <td>50 ÷ 110V (L-N)</td> <td>86÷190 V (L-L)</td> </tr> <tr> <td>110 ÷ 240V (L-N)</td> <td>190÷415 V (L-L)</td> </tr> <tr> <td>240 ÷ 1000 V (L-N)</td> <td>415÷1730 V (L-L)</td> </tr> </tbody> </table>	1W and 4W	3W	50 ÷ 110V (L-N)	86÷190 V (L-L)	110 ÷ 240V (L-N)	190÷415 V (L-L)	240 ÷ 1000 V (L-N)	415÷1730 V (L-L)
1W and 4W	3W								
50 ÷ 110V (L-N)	86÷190 V (L-L)								
110 ÷ 240V (L-N)	190÷415 V (L-L)								
240 ÷ 1000 V (L-N)	415÷1730 V (L-L)								
Voltage ratio	<p>Scaling factor for voltage transducer. Use this factor if external voltage transformers or dividers should be taken into account. All readings are then related to the primary voltage. See 4.2.2 for connection details.</p> <p>Note: scale factor can be set only when the lowest Voltage range is selected!</p> <p>Note: Maximum value is limited to 4000.</p>								
Ph. Curr. Clamps	<p>Select phase clamps for phase current measurements.</p> <p>Note: For Smart clamps (A 1227, A 1281) always select "Smart clamps".</p> <p>Note: See section 4.2.3 for details regarding further clamps settings.</p>								
N. Curr. Clams	<p>Select clamps for neutral current measurements.</p> <p>Note: For Smart clamps (A 1227, A 1281) always select "Smart type clamps".</p> <p>Note: See section 4.2.3 for details regarding further clamps settings.</p>								







	
<p>Connection</p>  <p>1W 4W 3W</p>	<p>Method of connecting the instrument to multi phase systems (see 4.2.1 for details).</p> <ul style="list-style-type: none"> • 1W: 1-phase 2-wire system; • 3W: 3-phase 3-wire system; • 4W: 3-phase 4-wire system.
<p>Synchronization</p>	<p>Synchronization channel. This channel is used for instrument synchronization to the network frequency. Also a frequency measurement is performed on that channel. Depending on Connection user can select:</p> <ul style="list-style-type: none"> • 1W: U1 or I1. • 3W: U12, or I1. • 4W: U1, I1.
<p>System frequency</p>	<p>Select system frequency.</p> <ul style="list-style-type: none"> • 50 Hz • 60 Hz
<p>Default parameters</p>	<p>Set factory default. These are: Nominal range: 110 ÷ 240V (L-N); Voltage ratio: 1:1; Phase current clamps: Smart Clamps; Neutral current clamps: Smart Clamps; Connection: 4W; Synchronization: U1 System frequency: 50 Hz.</p>

Table 3.79: Keys functions

	<p>Change selected parameter value.</p>
	<p>Select Connection setup parameter.</p>
	<p>Enter into submenu. Confirm Default parameters.</p>
	<p>Back to the “MEASUREMENT SETUP” menu screen.</p>

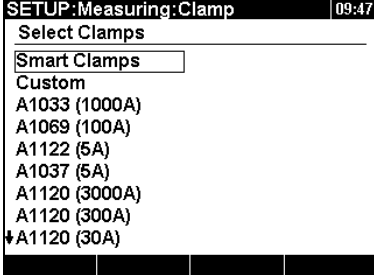
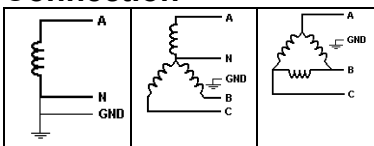
3.16.2 Event setup

In this menu you can setup voltage events and their parameters. See 5.1.12 for further details regarding measurement methods. Captured events can be observed through EVENTS TABLE menu. See 3.13 for details.

SETUP:Voltage Events		01:21
Nominal voltage:	230.0V	
Swell:	253.0V +10.0%	
Dip:	207.0V -10.0%	
Interrupt:	11.5V 5.0%	
Capture Events:	Disabled	

Figure 3.55: Voltage events setup screen.

Table 3.80: Description of Voltage event setup



Nominal voltage	Set nominal voltage.
Swell	Set swell threshold value.
Dip	Set dip threshold value.
Interrupt	Set interrupt threshold value.
Capture Events	Enable or disable event capturing.

Note: Enable events only if you want to capture it without recording. In case you want observe events only during recording use option:

Include active events: On in GENERAL RECORDER menu.

Note: In case of Connection type: 1W, it is recommended to connect unused voltage inputs to N voltage input in order to avoid false triggering.

Table 3.81: Keys function

	Change value.
	Select Voltage events setup parameter.
	Back to the "MEASUREMENT SETUP" menu screen.

3.16.3 Alarm setup

You can define up to 10 different alarms, based on any measurement quantity which is measured by instrument. See 5.1.13 for further details regarding measurement methods. Captured events can be observed through ALARMS TABLE menu. See 3.14 for details.

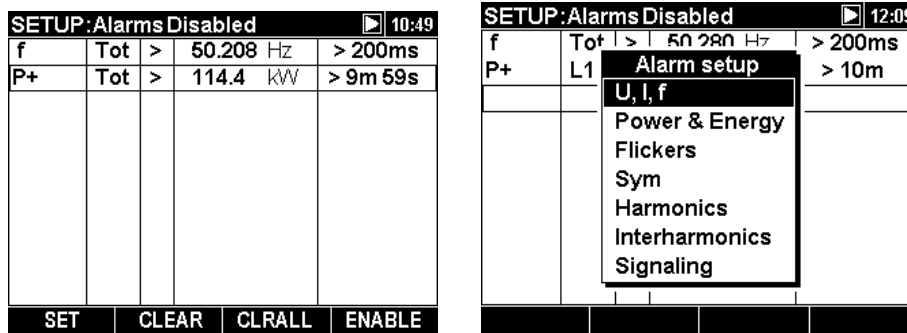





Figure 3.56: Alarms setup screen.

Table 3.82: Description of Alarms setup

1 st column (f, P+ on figure above)	Select alarm from measurement group and then measurement itself.
2 nd column (Tot on figure above)	Select phases for alarms capturing <ul style="list-style-type: none"> • L1 – alarms on phase L₁; • L2 – alarms on phase L₂; • L3 – alarms on phase L₃; • LN – alarms on phase N; • L12 – alarms on line L₁₂; • L23 – alarms on line L₂₃; • L31 – alarm on line L₃₁; • ALL – alarms on any phase; • Tot – alarms on power totals or non phase measurements (frequency, unbalance).
3 rd column (“>” on figure above)	Select triggering method: < – trigger when measured quantity is lower than threshold (FALL); > – trigger when measured quantity is higher than threshold (RISE);
4 th column	Threshold value.
5 th column	Minimal alarm duration. Trigger only if threshold is crossed for a defined period of time. Note: It is recommended that for flicker measurement, recorder is set to 10 min.

Table 3.83: Keys functions

F2	CLEAR	Clear selected alarm.
F3	CLRALL	Clear all alarms.
F4	ENABLE	Disable or enable alarms. Note: Enable alarms only if you want to capture alarms without recording. In case you want observe alarms only during recording use option <code>Include active alarms: On</code> in RECORDER menu.
	DISABL	

	Enter or exit a sub menu to set an alarm.
	Cursor keys. Select parameter.
	Cursor keys. Select parameter or change value.
	Confirm setting of an alarm Back to the “MEASUREMENT SETUP” menu screen.

3.16.4 Signalling setup

Mains Signalling is classified in four groups:

- ripple control systems (110 Hz to 3000 Hz);
- medium-frequency power-line carrier systems (3kHz – 20kHz);
- radio-frequency power-line carrier systems (20kHz – 148.5kHz);
- mains-mark system.

User can define two different signalling frequencies. Signals can be used as a source for the user defined alarm and can also be included in recording. See section 3.16.3 to learn how to set up alarms. See section 3.7.3 for instructions how to start recording.

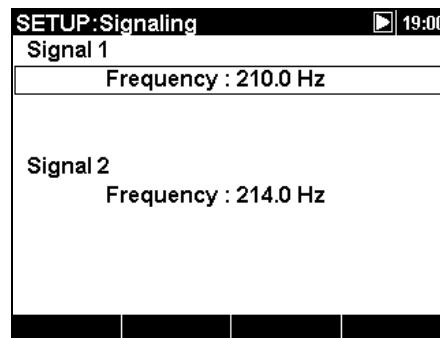





Figure 3.57: Signalling setup screen.

Table 3.84: Keys functions

	Change frequency value.
	Switch between Signal 1 / Signal 2.
	Back to the “MEASUREMENT SETUP” menu screen.

3.17 General Setup menu

From the “GENERAL SETUP” menu communication parameters, real clock time, language can be reviewed, configured and saved.

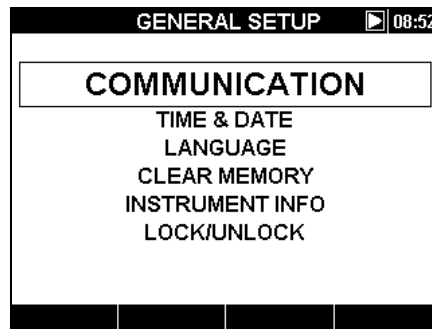





Figure 3.58: GENERAL SETUP menu

Table 3.85: Description of General setup options

Communication	Setup communication baud rate and source.
Time & Date	Set time and date.
Language	Select language.
Clear Memory	Clear instrument memories.
Instrument info	Information about the instrument.
Lock/Unlock	Lock instrument to prevent unauthorized access.

Table 3.86: Keys functions

	Select function from the “GENERAL SETUP” menu.
	Enter the selected item.
	Back to the “MAIN MENU” screen.

3.17.1 Communication

Communication port (RS232, USB, or GPRS) and communication speed can be set in this menu.

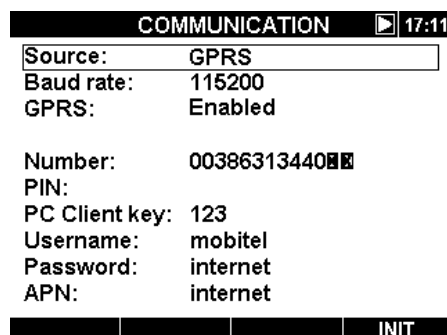







Figure 3.59: Communication setup screen

Table 3.87: Description of Communication setup options

Source:	Select RS-232, USB or GPRS communication port.
Baud rate:	Select port speed.
GPRS*:	Show status of GPRS communication. GPRS is enabled only after INIT sequence was successfully applied.
Number*:	Phone number of GPRS modem. Phone number is defined with SIM card.
PIN*:	SIM Card PIN code. Optional parameter which should be entered only if it was activated on SIM card.
Secret key*:	Key number which assure additional protection of communication link. Same number should be entered later in PowerView v2.0, before connection establishment.
Username*:	APN username, provided by mobile operator.
Password*:	APN password, provided by mobile operator.
APN*:	Access point name. Unique identifier that allows connection to the network, provided by mobile operator.

* Settings needed for GPRS communication are shown in section 4.2.6 (optional accessory A 1356). For further information refer to A 1356 GPRS Modem User manual.

Table 3.88: Keys functions

	INIT Initialize GPRS modem. See section 4.2.6 for details.
	Change communication source (RS – 232, USB) Change communication speed from 2400 baud to 115200 baud for RS232 and from 2400 baud to 921600 baud for USB. Move cursor position during procedure of entering GPRS modem parameters.
	Cursor keys. Select parameter. Switch between characters and numbers during procedure of entering GPRS parameters.
	Edit selected parameter of GPRS modem.
	Back to the “GENERAL SETUP” menu screen.

3.17.2 Time & Date

Time and date can be set in this menu.

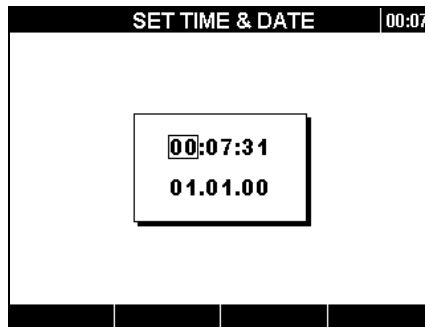





Figure 3.60: Set time & date screen

Table 3.89: Keys functions

	Select between the following parameters: hour, minute, second, day, month or year.
	Change value of the selected item.
	Return to the "GENERAL SETUP" menu screen.

Note: PowerQ4 Plus has the ability to synchronize its system time clock with Coordinated Universal Time (UTC time) provided by externally connected GPS module. In that case only hours (time zone) can be adjusted. In order to use this functionality, see 4.2.5.



3.17.3 Language

Different languages can be selected in this menu.



Figure 3.61: Language setup screen

Table 3.90: Keys functions

	Select language.
	Confirm the selected language.
	Back to the “GENERAL SETUP” menu screen.

3.17.4 Clear Memory

Use this menu in order to clear different instrument memory. User can select one of following items to clear:

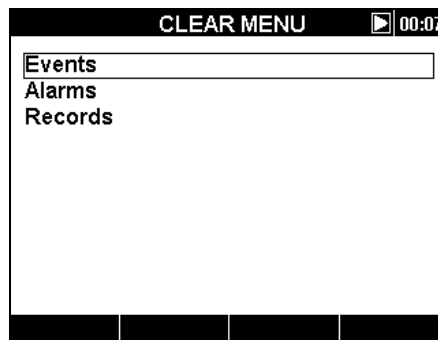





Figure 3.62: Clear menu screen

Table 3.91: Description of Clear menu options

Events:	Clear Voltage EVENTS table.
Alarms:	Clear ALARMS table.
Records:	Clear all stored records.

Table 3.92: Keys functions

	Select option to clear.
	Confirm to clear.
	Back to the “GENERAL SETUP” menu screen.

3.17.5 Instrument info

Basic information concerning the instrument can be viewed in this menu: company, user data, serial number, firmware version and hardware version.

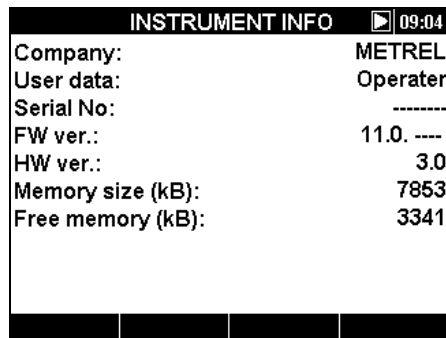

Figure 3.63: Instrument info screen

Table 3.93: Keys functions



Back to the "GENERAL SETUP" menu screen.

3.17.6 Lock/Unlock

PowerQ4 Plus has the ability to prevent unauthorized access to all important instrument functionality by simply locking the instrument. There are several reasons for instrument locking, especially if instrument is left for a longer period at an unsupervised measurement spot. Some reasons are: prevention of unintentional stopping of record, changing of instrument or measurement setup, etc. Although instrument lock prevent unauthorized changing of instrument working mode, it does not prevent non-destructive operation as displaying current measurement values or trends.

User locks the instrument by entering secret lock code in the Lock/Unlock screen.

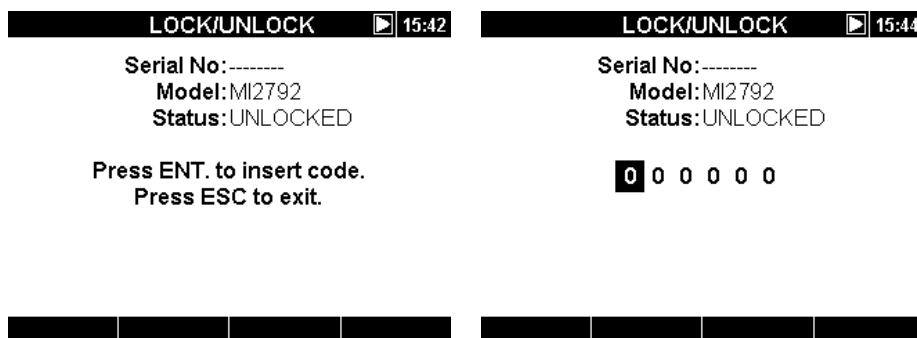





Figure 3.64: Lock/Unlock screen

Table 3.94: Keys function

	Select digit
	Change value of the selected digit
	Set / Confirm lock code.
	Back to the “GENERAL SETUP” menu screen.

Following table shows how locking impacts instrument functionality.

Table 3.95: Locked instrument functionality

MEASUREMENTS	Waveform snapshot functionality blocked
RECORDERS	No access
MEASUREMENT SETUP	No access
GENERAL SETUP	No access except to Lock/Unlock menu

A warning message appears if user tries to enter restricted instrument functions. By pressing ENTER during the warning message appearance, the LOCK/UNLOCK screen will be entered where the instrument can be unlocked by entering the previously entered lock code.

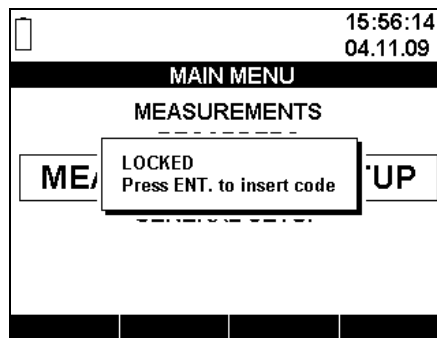

Figure 3.65: Locked instrument warning message

Note: In case user forget unlock code, general unlock code “120371” can be used to unlock the instrument.

4 Recording Practice and Instrument Connection

In following section recommended measurement and recording practice is described.

4.1 Measurement campaign

Power quality measurements are specific type of measurements, which can last many days, and mostly they are *performed* only once. Usually recording campaign is performed to:

- Statistically analyze some points in the network.
- Troubleshoot malfunctioning device or machine

Since measurements are mostly *performed* only once, it is very important to properly set measuring equipment. Measuring with wrong setting can lead to false or useless measurement results. Therefore instrument and user should be fully prepared before measurement begins.

In this section recommended recorder procedure is shown. We recommend to strictly follow guidelines in order to avoid common problems and measurement mistakes. Figure bellow shortly summarizes recommended measurement practice. Each step is then described in details.

Note: PC software PowerView v2.0 has the ability to correct (after measurement is done):

- wrong real-time settings,
- wrong current and voltage scaling factor.

False instrument connection (messed wiring, opposite clamp direction), can't be fixed afterwards.

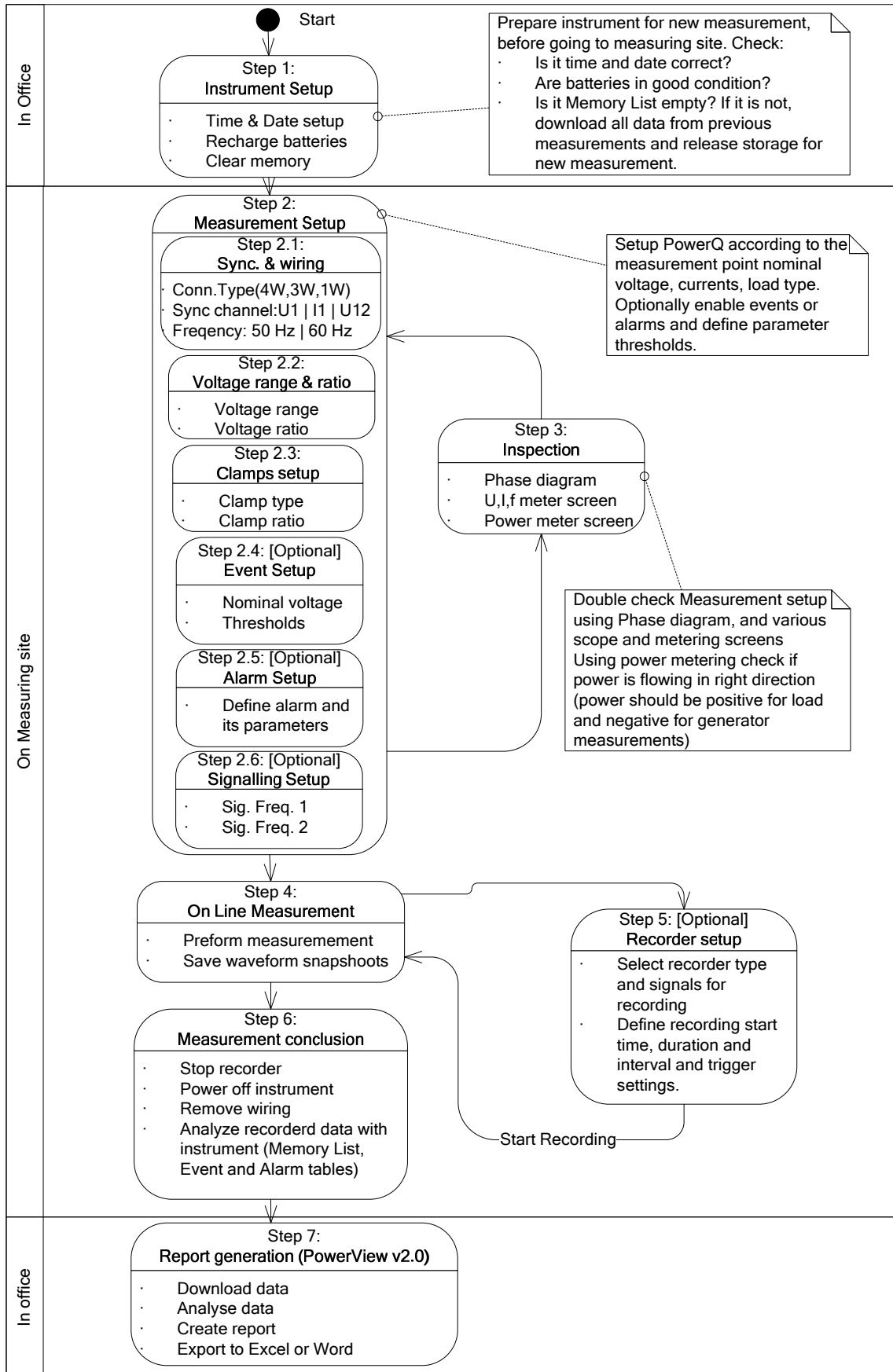

Figure 4.1: Recommended measurement practice

Step 1: Instrument setup

On site measurements can be very stressful, and therefore it is good practice to prepare measurement equipment in an office. Preparation of PowerQ4 Plus include following steps:

- Visually check instrument and accessories.
Warning: Don't use visually damaged equipment!
- Always use batteries that are in good condition and fully charge them before you leave.
Note: Keep your batteries in good condition. In problematic PQ environment where dips and interrupts frequently occurs instrument power supply fully depends on batteries!
- Download all previous records from instrument and clear the memory. (See section 3.10 for instruction regarding memory clearing)
- Set instrument time and date. (See section 0 for instruction regarding time and date settings)

Step 2: Measurement setup

Measurement setup adjustment is *performed* on measured site, after we find out details regarding nominal voltage, currents, type of wiring etc.

Step 2.1: Synchronization and wiring

- Connect current clamps and voltage tips to the "Device under measurement" (See section 4.2 for details).
- Select proper type of connection in "Connection setup" menu (See section 3.16.1 for details).
- Select synchronization channel. Synchronization to voltage is recommended, unless measurement is performed on highly distorted loads, such as PWM drives. In that case current synchronization can be more appropriate. (See section 3.16.1 for details).
- Select System frequency. System frequency is default mains system frequency. Setting this parameter is recommended if user measure signalling or flickers.

Step 2.2: Voltage range and ratio

- Select proper voltage range according to the network nominal voltage.
Note: For 4W and 1W measurement all voltages are specified as phase-to-neutral (L-N). For 3W measurements all voltages are specifies as phase-to-phase (L-L)
Note: Instrument assures proper measurement up to 150 % of chosen nominal voltage.
- In case of indirect voltage measurement, select voltage range: 50 V ÷ 110 V and select "Voltage ratio" according to transducer ratio. (See section 3.16.1 for details).

Step 2.3: Current clamps setup

- Using "Current Clamps" menu, select proper clamps (see sections 3.16.1 for details).
- Select proper clamps parameters according to the type of connection (see section 4.2.3 for details).

Step 2.4: Event setup (optional)

Use this step only if voltage events are object of concern. Select nominal voltage and threshold values for: dip, swell and interrupts (see sections 3.16.2 and 3.13 for details).

Note: Enable events in EVENT SETUP only if you want to capture events, without RECORDER assistance.

Step 2.5: Alarm setup (optional)

Use this step only if you would like only to check if some quantities cross some predefined boundaries (see sections 3.14 and 3.16.3 for details).

Note: Enable alarms capture only if want to capture alarms, without assistance of RECORDER.

Step 2.6: Signalling setup (optional)

Use this step only if you are interested in measuring mains signalling voltage.

Step 3: Inspection

After setup instrument and measurement is finished, user need to recheck if everything is connected and configured properly. Following steps are recommended.

- Using PHASE DIAGRAM menu check if voltage and current phase sequence is right regarding to the system. Additionally check if current has right direction.
- Using U, I, f menu check if voltage and current value has proper value.
- Additionally check voltage and current THD.

Note: Excessive THD can indicate that too small range was chosen!

Note: In case of AD converter overloading current and voltage value will be displayed with inverted color **250.4 V**.

Note: If phase current or voltage value are not within 10% ÷ 150% of the range, their values will be displayed with inverted color **0.4 V**.

- Using POWER menu check signs and indices of active, reactive power and power factor.

If any of these steps give you suspicious measurement results, return to Step 2 and double check measurement parameters.

Step 4: On-line measurement

Instrument is now ready for measurement. Observe on line parameters of voltage, current, power, harmonics, etc. according to the measurement protocol or customer issues.

Note: Use waveform snapshots to capture important measurement. Waveform snapshot capture all power quality signatures at once (voltage, current, power, harmonics, flickers).

Step 5: Recorder setup and recording

Using RECORDERS menu select type of recording and configure recording parameters such as:

- Recorder **Signals** included in recording
- Time **Interval** for data aggregation (IP)
- Record duration
- Recording start time (optional)

- Include events and alarms capture if necessary

After setting recorder, recording can be started. (see section 3.9 for recorder details).

Note: Recording usually last few days. Assure that instrument during recording session is not reachable to the unauthorized persons. If necessary use LOCK functionality described in section 3.17.6.

Step 6: Measurement conclusion

Before leaving measurement site we need to

- Preliminary evaluate recorded data using TREND screens.
- Stop recorder
- Assure that we record and measure everything we needed.

Step 7: Report generation (PowerView v2.0)

Download records using PC software PowerView v2.0 and perform analysis. See PowerView v2.0 manual for details.

4.2 Connection setup

4.2.1 Connection to the LV Power Systems

This instrument can be connected to the 3-phase and single phase network.

The actual connection scheme has to be defined in CONNECTION SETUP menu (see Figure below).

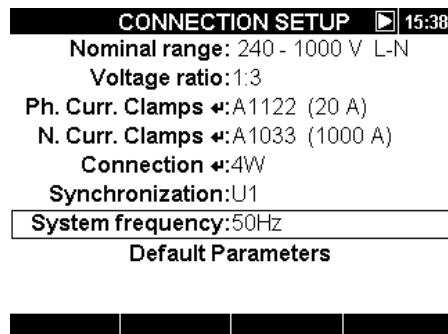

Figure 4.2: Connection setup menu

When connecting the instrument it is essential that both current and voltage connections are correct. In particular the following rules have to be observed:

Clamp-on current clamp-on transformers

- The arrow marked on the clamp-on current transformer should point in the direction of current flow, from supply to load.
- If the clamp-on current transformer is connected in reverse the measured power in that phase would normally appear negative.

Phase relationships

- The clamp-on current transformer connected to current input connector I_1 has to measure the current in the phase line to which the voltage probe from L_1 is connected.

3-phase 4-wire system

In order to select this connection scheme, choose following connection on the instrument:

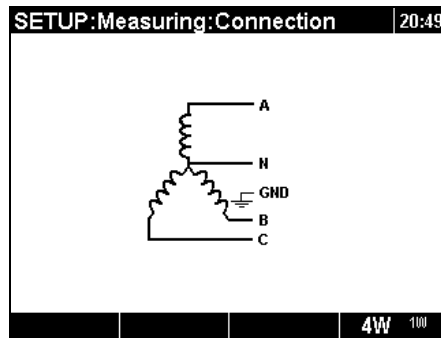

Figure 4.3: Choosing 3-phase 4-wire system on instrument

Instrument should be connected to the network according to figure below:

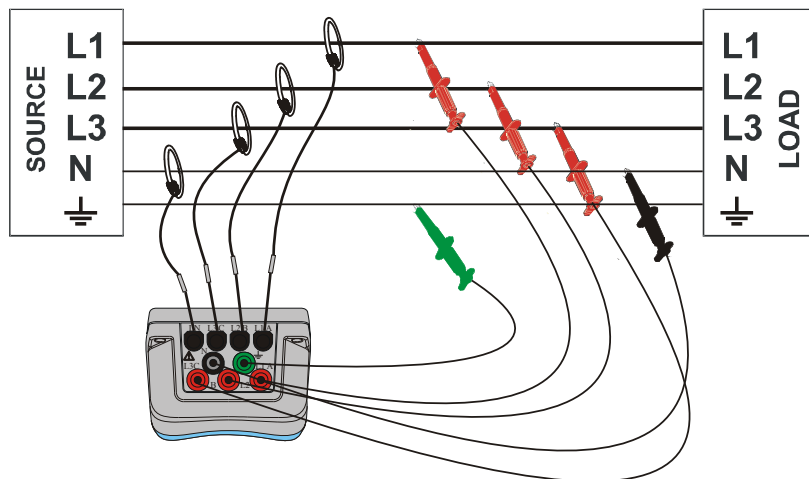

Figure 4.4: 3-phase 4-wire system

3-phase 3-wire system

In order to select this connection scheme, choose following connection on the instrument:

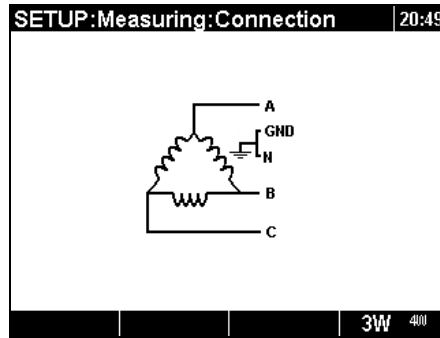

Figure 4.5: Choosing 3-phase 3-wire system on instrument

Instrument should be connected to the network according to figure below.

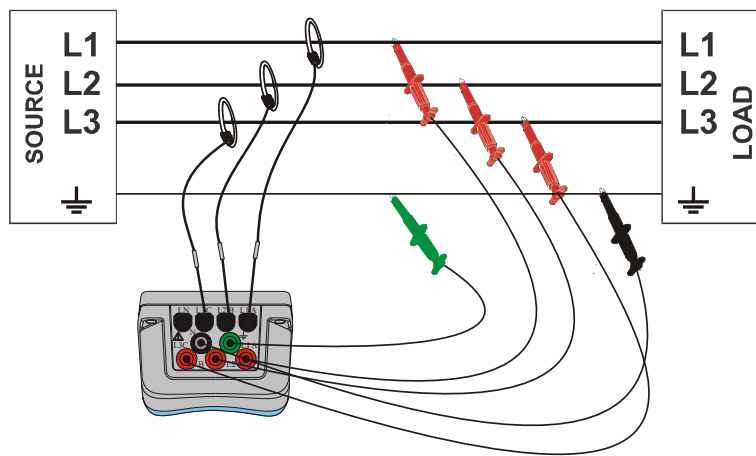

Figure 4.6: 3-phase 3-wire system

Open delta 3-wire system

In order to select this connection scheme, choose following connection on the instrument:

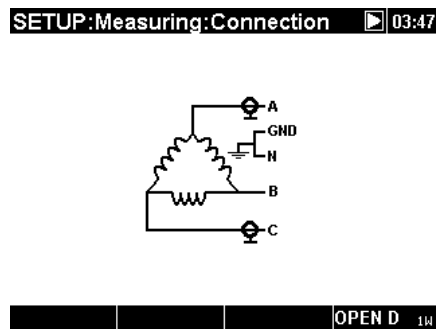

Figure 4.7: Choosing open delta 3-wire system on instrument

Instrument should be connected to the network according to figure below.

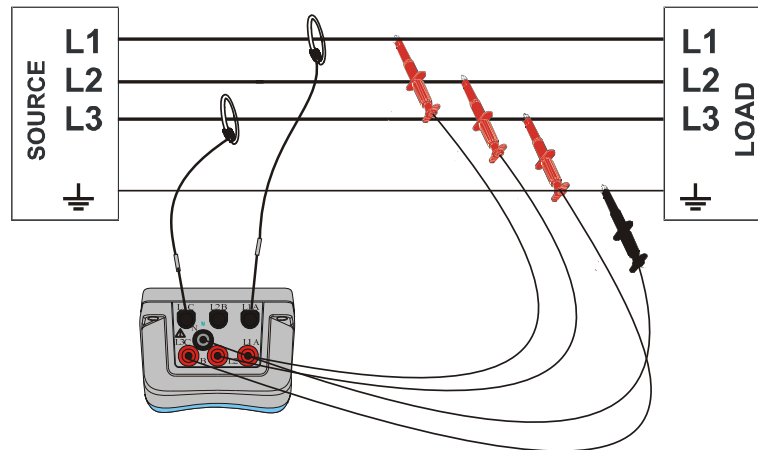

Figure 4.8: Open delta 3-wire system

1-phase 3-wire system

In order to select this connection scheme, choose following connection on the instrument:

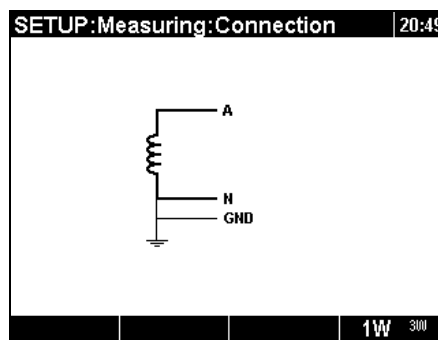

Figure 4.9: Choosing 1-phase 3-wire system on instrument

Instrument should be connected to the network according to figure bellow.

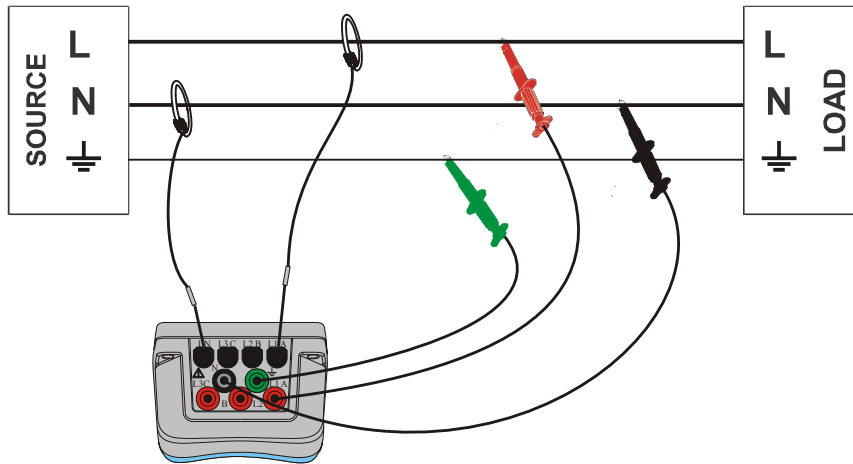

Figure 4.10: 1-phase 3-wire system

Note: In case of events capturing, it is recommended to connect unused voltage inputs to N voltage input.

4.2.2 Connection to the MV or HV Power System

In systems where voltage is measured at the secondary side of a voltage transformer (say 11 kV / 110 V), the instrument voltage range should be set to 50÷110 V and scaling factor of that voltage transformer ratio has to be entered in order to ensure correct measurement. In the next figure settings for this particular example is shown.

MEASURING SETUP		21:23
Voltage range: 50 - 110 V L-N		
Voltage ratio: 1:100		
Ph. Curr. Clamps ↕: Smart Clamps		
N. Curr. Clamps ↕: Smart Clamps		
Connection ↕: 4W		
Synchronization: U1		
Default Parameters		

Figure 4.11: Voltage ratio for 11kV/110kV transformer example

Instrument should be connected to the network according to figure bellow.

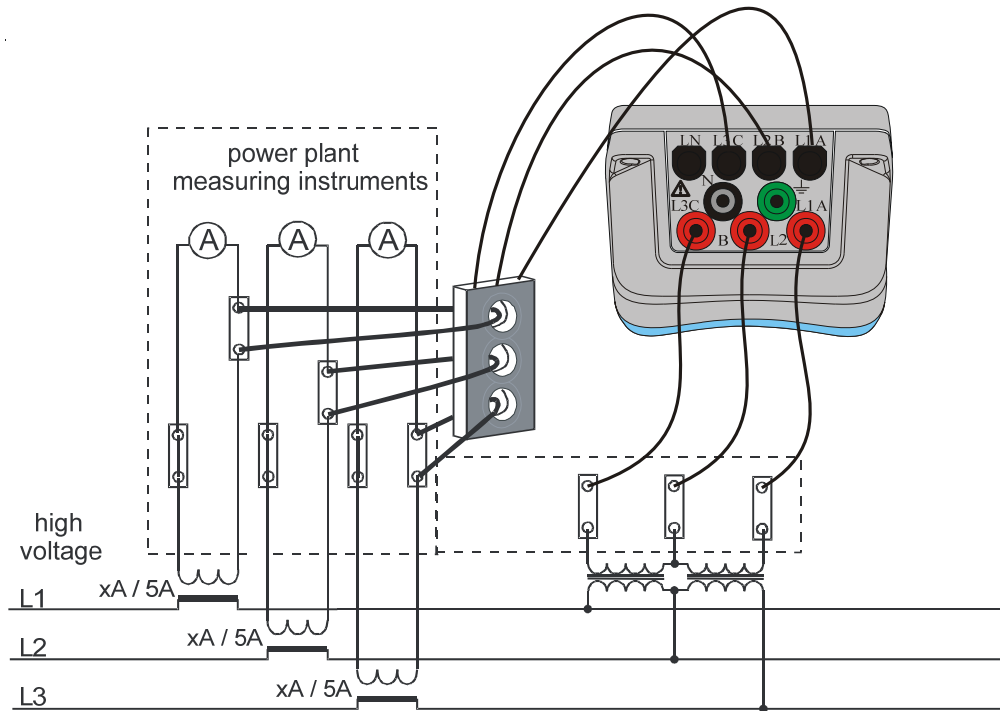

Figure 4.12: Connecting instrument to the existing current transformers in medium voltage system

4.2.3 Current clamp selection and transformation ratio setting

Clamp selection can be explained by two typical use cases: **direct current measurement** and **indirect current measurement**. In next section recommended practice for both cases is shown.

Direct current measurement with clamp-on current transformer

In this type of measurement load/generator current is measured directly with one of clamp-on current transformer. Current to voltage conversion is *performed directly* by the clamps.

Direct current measurement can be *performed* by any clamp-on current transformer. We particularly recommend Smart clamps: flex clamps A 1227 and iron clamps A 1281. Also older Metrel clamp models A 1033 (1000A), A1069 (100A), A1120 (3000A), A1099 (3000A), etc. can be used.

In the case of large loads there can be few parallel feeders which can't be embraced by single clamps. In this case we can measure current only through one feeder as shown on figure bellow.

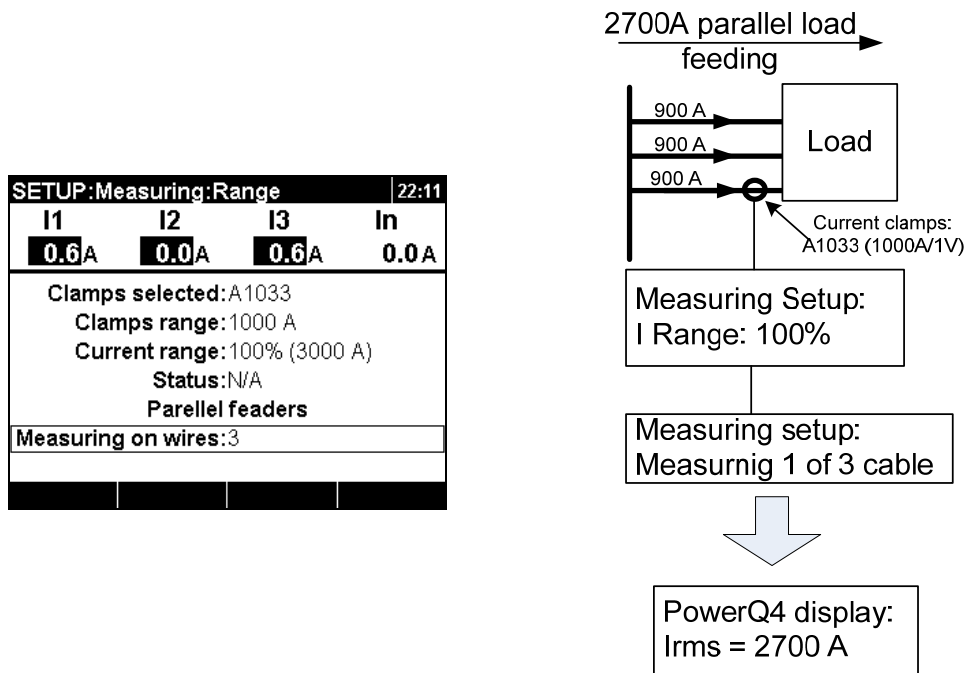

Figure 4.13: Parallel feeding of large load

Example: 2700 A current load is fed by 3 equal parallel cables. In order to measure current we can embrace only one cable with clamps, and select: Measuring on wires: 3 in clamp menu. Instrument will assume that we measure only third part of current.

Note: During setup current range can be observed by “Current range: 100% (3000 A)” row.

Indirect current measurement

Indirect current measurement with primary current transducer is assumed if user selects 5A current clamps: A 1122 or A 1037. Load current is that case measured **indirectly** through additional primary current transformer.

In **example** if we have 100A of primary current flowing through primary transformer with ratio 600A:5A, settings are shown in following figure.

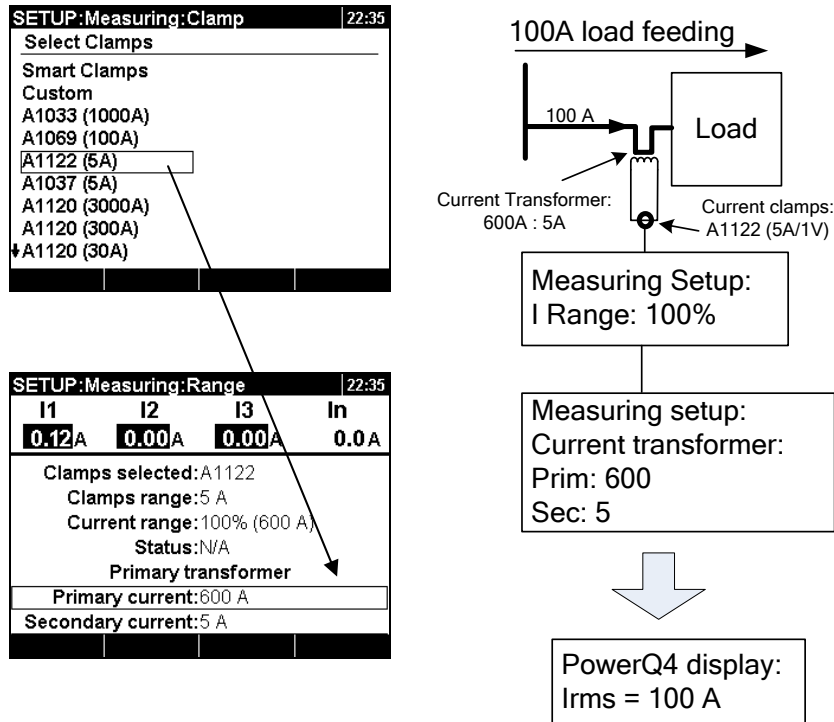

Figure 4.14: Current clamps selection for indirect current measurement

Over-dimensioned current transformer

Installed current transformers on the field are usually over-dimensioned for “possibility to add new loads in future”. In that case current in primary transformer can be less than 10% of rated transformer current. For such cases it is recommended to select 10% current range as shown on figure bellow.

SETUP: Measuring: Range 22:36			
I1	I2	I3	In
0.060A	0.060A	0.060A	0.10A
Clamps selected: A1122			
Clamps range: 5 A			
Current range: 10% (60.0 A)			
Status: N/A			
Primary transformer			
Primary current: 600 A			
Secondary current: 5 A			

Figure 4.15: Selecting 10% of current clamps range

Note that if we want to perform direct current measure with 5 A clamps, primary transformer ratio should be set to 5 A : 5 A.

⚠ WARNING !

- The secondary winding of a current transformer must not be open when it is on a live circuit.
- An open secondary circuit can result in dangerously high voltage across the terminals.

Automatic current clamps recognition

Metrel developed Smart current clamps product family in order to simplify current clamps selection and settings. Smart clamps are multi-range switch-less current clamps automatically recognized by instrument. In order to activate smart clamp recognition, the following procedure should be followed for the first time:

1. Turn on instrument
2. Connect clamps (for example A 1227) into PowerQ4 Plus
3. Enter: Measurement Setup → Connection setup → Ph./N. Curr. Clamps menu
4. Select: Smart clamps
5. Clamps type will be automatically recognized by the instrument.
6. User should then select clamp range and confirm settings

SETUP:Measuring:Range				18:27
I1	I2	I3	In	
29.1A	0.6A	1.8A	2.5A	
Clamps selected:A1227				
Clamps range:3000 A				
Current range:100% (3000 A)				
Status:Clamps 2 3 missing				
Parallel feeders				
Measuring on wires:1				

Figure 4.16: Automatically recognised clamps setup

Instrument will remember clamps setting for the next time. Therefore, user only need to:

1. Plug clamps into the instrument
2. Turn on the instrument

Instrument will recognize clamps automatically and set up ranges as was settled on measurement before. If clamps were disconnected following pop up will appear on the screen.

MAIN MENU		15:06:08
MEASUREMENTS		06.11.09
CLAMPS STATUS		
Setup:	x x x x	
Online:	I1 x x x	

Figure 4.17: Automatically recognised clamps status

Clamps Status menu indicate that there is an inconsistency between current clamp defined in Clamps Setup menu and clamps present at the moment. For example, figure above show that in setup no clamp were defined (X), but at the moment there are clamps present on I1 current channel.

Table 4.1: Clamp status screen symbols and abbreviations

Setup	<p>Show clamps, which were connected during clamp setup in Measurement setup → Connection Setup → Ph./N. Curr. clamps</p> <ul style="list-style-type: none"> • X: clamps on present current channel are missing • I1/I2/I3/In: clamps were present and defined during setup • Ts: temperature probe was present and defined during setup
Online	<p>Show clamps which are connected to the instrument at the moment:</p> <ul style="list-style-type: none"> • X: clamps on present current channel are missing • I1/I2/I3/In: clamps are present at the moment • Ts: temperature probe is present at the moment

Note: Do not disconnect smart clamps during recording or measurement. Clamps range will be reset if clamps are plugged out of the instrument.

4.2.4 Temperature probe connection

Temperature measurement is performed using smart temperature probe connected to the neutral current input channel IN. In order to activate smart clamp recognition, following procedure should be followed for the first time:

1. Turn on instrument
2. Connect temperature probe into PowerQ4 Plus neutral current input
3. Enter: Measurement setup → Connection setup → N. Curr. clamps
4. Select: Smart clamps
5. Temperature probe will be automatically recognized by the instrument.
6. User should then confirm settings

SETUP:Measuring:Range				12:42
I1	I2	I3	In	
1768A	1768A	1768A	530.2A	
Clamps selected:Temp. Sensor				
Clamps range:N/A				
Current range:N/A				
Status:Clamps N OK				

Figure 4.18: Automatically recognized temperature probe setup

Instrument will remember settings for the next time. Therefore, user only need to:

1. Plug temperature probe into the instrument
2. Turn on the instrument

Instrument will recognize temperature probe automatically. Following pop up window will appear on the screen if temperature probe was connected or disconnected.

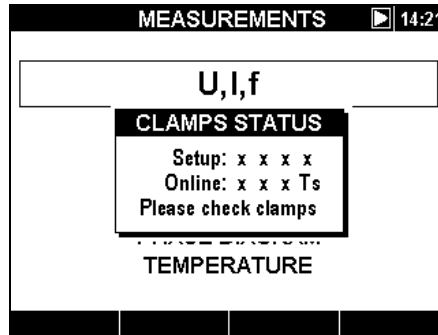

Figure 4.19: Detected temperature probe pop up window

4.2.5 GPS time synchronization device connection

PowerQ4 Plus has the ability to synchronize its system time clock with Coordinated Universal Time (UTC time) provided by externally connected GPS module (optional accessory - A 1355). In order to be able to use this particular functionality, USB port must be selected as the primary communication port. Once this is done, GPS module can be attached to the PS/2 communication port. PowerQ4 Plus distinguishes two different states regarding GPS module functionality.

Table 4.2: GPS functionality

	GPS module detected, position not valid or no satellite GPS signal reception.
	GPS module detected, satellite GPS signal reception, date and time valid and synchronized, synchronization pulses active

Once an initial position fix is obtained, instrument will demand from the user to set the correct time zone (see figure below).

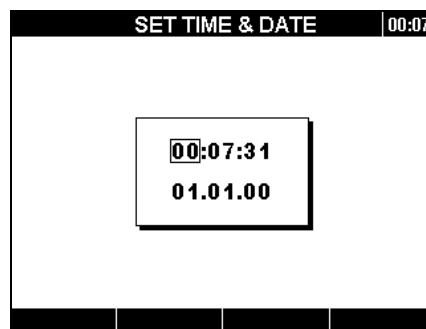

Figure 4.20: Set time zone screen.

Table 4.3: Keys function

	Set time zone
	Exit

When the time zone is set, PowerQ4 Plus will synchronize its system time clock and internal RTC clock with the received UTC time. GPS module also provides the instrument with extremely accurate synchronization pulses every second (PPS – Pulse Per Second) for synchronization purposes in case of lost satellite reception.

Note: GPS synchronization should be done before starting measurements.

For detailed information please check user manual of A 1355 GPS Receiver.

4.2.6 GPRS modem connection

PowerQ4 Plus can be remotely controlled through GPRS modem (optional accessory - A 1356). In order to establish remote connection with instrument through PC software PowerView v2.0, communication parameters should be configured. Figure below show COMMUNICATION menu in GENERAL SETUP.

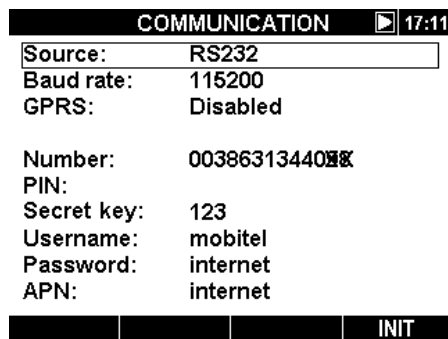

Figure 4.21: GPRS connection setup screen

Following parameters should be entered in order to establish GPRS communication:

Table 4.4: GPRS setup parameters

Number:	Required	Enter phone number
PIN:	Optional	Enter this parameter if it if your SIM card request. If you don't disable PIN code on your SIM card, put SIM Card into you mobile phone and disable it.
Secret key	Required	Enter number code (for example 3-digits). User need to store this number, as will be later asked by PowerView v2.0, during connection procedure
APN	Required	Those parameters are provided by your local mobile provider, from whom SIM card for GPRS modem was bought. They are required by GPRS modem in order to establish internet connection.
Username	Required	
Password	Required	

After entering parameters user should connect PowerQ4 Plus and modem with attached cable and activate initialization (**INIT**) by pressing on function key **F4**. New window will appear on screen and GPRS test will start.

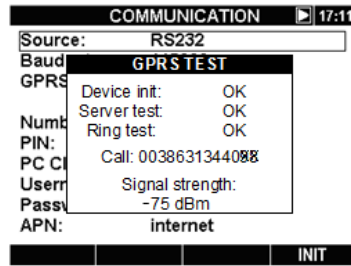

Figure 4.22: GPRS test screen

Modem status can be also observed on instrument Main Menu, as shown on figure below.

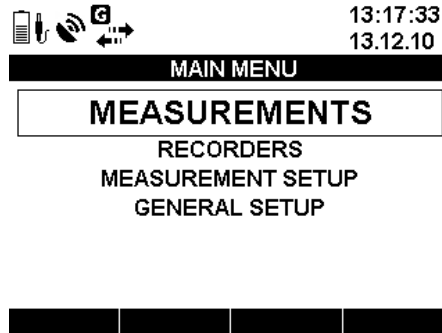

Figure 4.23: “MAIN MENU”

Table 4.5: GPRS modem symbols

	GPS module status (Optional accessory A 1355)
	GPS module detected but reporting invalid time and position data (searching for satellites or too weak satellite signal)
	GPS time valid – valid satellite GPS time signal)
	GPRS modem status (Optional accessory A 1356)
	GPRS is in initialization mode (see section 4.2.6 for details)
	GPRS modem is ready to receive user call (see section 4.2.6 for details)
	GPRS communication is in progress (see section 4.2.6 for details)

For detailed information please check user manual of A 1356 GPRS Modem.

4.3 Number of measured parameters and connection type relationship

Parameters which PowerQ4 Plus displays and measures, mainly depends on network type, defined in CONNECTION SETUP menu, Connection type. In example if user choose single phase connection system, only measurements relate to single phase system will be present. Table bellows show dependencies between measurement parameters and type of network.

Table 4.6: Quantities measured by instrument

Value		Connection type			
		1W	3W	4W	
U, I, f	RMS	U_{1rms} U_{Nrms}	U_{12rms} U_{31rms}	U_{23rms}	$U_{1rms} U_{2rms} U_{3rms} U_{Nrms}$ $U_{12rms} U_{23rms} U_{31rms}$
	THD	THD_{U1} THD_{UN}	THD_{U12} THD_{U31}	THD_{U23}	$THD_{U1} THD_{U2} THD_{U3} THD_{UN} THD_{U12} THD_{U23}$ THD_{U31}
	Cf	CfU_1 CfU_N	CfU_{12} CfU_{31}	CfU_{23}	$CfU_1 CfU_2 CfU_3 CfU_N$ $CfU_{12} CfU_{23} CfU_{31}$
	RMS	$I_{1rms} I_{Nrms}$	$I_{1rms} I_{2rms} I_{3rms}$		$I_{1rms} I_{2rms} I_{3rms} I_{Nrms}$
	THD	THD_{I1} THD_{IN}	THD_{I1} THD_{I3}	THD_{I2}	$THD_{I1} THD_{I2} THD_{I3} THD_{IN}$
	Cf	$CfI_1 CfI_N$	$CfI_1 CfI_2 CfI_3$		$CfI_1 CfI_2 CfI_3 CfI_N$
	freq	$freqU_1$ $freqI_1$	$freqU_{12}$ $freqI_1$		$freqU_1$ $freqI_1$
Power & Energy	P	$\pm P_1$	$\pm P_{tot}$		$\pm P_1 \pm P_2 \pm P_3 \pm P_{tot}$
	Q	$\pm Q_1$	$\pm Q_{tot}$		$\pm Q_1 \pm Q_2 \pm Q_3 \pm Q_{tot}$
	S	S_1	S_{tot}		$S_1 S_2 S_3 S_{tot}$
	PF	$\pm PF_1$	$\pm PF_{tot}$		$\pm PF_1 \pm PF_2 \pm PF_3 \pm PF_{tot}$
	DPF	$\pm DPF_1$			$\pm DPF_1 \pm DPF_2 \pm DPF_3 \pm DPF_{tot}$
Flicker	Pst (1min)	Pst_{1min1}	Pst_{1min12} Pst_{1min31}	Pst_{1min23}	$Pst_{1min1} Pst_{1min2} Pst_{1min3}$
	Pst	Pst_1	Pst_{12} Pst_{23} Pst_{31}		$Pst_1 Pst_2 Pst_3$
	Plt	Plt_1	Plt_{12} Plt_{23} Plt_{31}		$Plt_1 Plt_2 Plt_3$
Unbalance	%	-	$\bar{u} \bar{i}$		$u^0 i^0 \bar{u} \bar{i}$
	RMS		$U^+ U$ $I^+ I$		$U^+ U U^0$ $I^+ I I^0$
Harmonics and interharmonics	Uh _{1÷50}	$U_{1h1÷50}$ $U_{Nh1÷50}$	$U_{12h1÷50}$ $U_{31h1÷50}$	$U_{23h1÷50}$	$U_{1h1÷50} U_{2h1÷50} U_{3h1÷50} U_{Nh1÷50}$
	Ih _{1÷50}	$I_{1h1÷50}$ $I_{Nh1÷50}$	$I_{1h1÷50}$ $I_{3h1÷50}$	$I_{2h1÷50}$	$I_{1h1÷50} I_{2h1÷50} I_{3h1÷50} I_{Nh1÷50}$
	Uih _{1÷50}	$U_{1ih1÷50}$ $U_{Nih1÷50}$	$U_{12ih1÷50}$ $U_{23ih1÷50}$ $U_{31ih1÷50}$		$U_{1ih1÷50} U_{2ih1÷50} U_{3ih1÷50} U_{Nih1÷50}$
	Iih _{1÷50}	$I_{1ih1÷50}$ $I_{Nih1÷50}$	$I_{1ih1÷50}$ $I_{3ih1÷50}$	$I_{2ih1÷50}$	$I_{1ih1÷50} I_{2ih1÷50} I_{3ih1÷50} I_{Nih1÷50}$

Note: Frequency measurement depends on synchronization (reference) channel, which can be voltage or current.

In the same manner recording quantities are related to connection type too. When user selects **Signals** in RECORDER menu, channels selected for recording are chosen according to the **Connection** type, according to the next table.

Table 4.7: Quantities recorder by instrument

		Value	1-phase	3W	4W
U, I, f	Voltage	RMS	$U_{1Rms} U_{NRms}$	$U_{12Rms} U_{23Rms} U_{31Rms}$	$U_{1Rms} U_{2Rms} U_{3Rms} U_{NRms} U_{12Rms} U_{23Rms} U_{31Rms}$
		THD	$THD_{U1} THD_{UN}$	$THD_{U12} THD_{U23} THD_{U31}$	$THD_{U1} THD_{U2} THD_{U3} THD_{UN} THD_{U12} THD_{U23} THD_{U31}$
		CF	$CfU_1 CfU_N$	$CfU_{12} CfU_{23} CfU_{31}$	$CfU_1 CfU_2 CfU_3 CfU_N CfU_{12} CfU_{23} CfU_{31}$
	Current	RMS	$I_{1rms} I_{Nrms}$	$I_{1rms} I_{2rms} I_{3rms}$	$I_{1rms} I_{2rms} I_{3rms} I_{Nrms}$
		THD	$THD_{I1} THD_{IN}$	$THD_{I1} THD_{I2} THD_{I3}$	$THD_{I1} THD_{I2} THD_{I3} THD_{IN}$
		CF	$CfI_1 CfI_N$	$CfI_1 CfI_2 CfI_3$	$CfI_1 CfI_2 CfI_3 CfI_N$
Frequency	f	$freqU_1 freqI_1$	$freqU_{12} freqI_1$	$freqU_1 freqI_1$	
Power & Energy	Power	P	$P_1^+ P_1^-$	$P_{tot}^+ P_{tot}^-$	$P_1^+ P_1^- P_2^+ P_2^- P_3^+ P_3^- P_{tot}^+ P_{tot}^-$
		Q	$Q_1^{i+} Q_1^{c+} Q_1^{i-} Q_1^{c-}$	$Q_{tot}^{i+} Q_{tot}^{c+} Q_{tot}^{i-} Q_{tot}^{c-}$	$Q_1^{i+} Q_1^{c+} Q_1^{i-} Q_1^{c-} Q_2^{i+} Q_2^{c+} Q_2^{i-} Q_2^{c-} Q_3^{i+} Q_3^{c+} Q_3^{i-} Q_3^{c-} Q_{tot}^{i+} Q_{tot}^{c+} Q_{tot}^{i-} Q_{tot}^{c-}$
		S	$S_1^+ S_1^-$	$S_{tot}^+ S_{tot}^-$	$S_1^+ S_1^- S_2^+ S_2^- S_3^+ S_3^- S_{tot}^+ S_{tot}^-$
	Energy	eP	$eP_1^+ eP_1^-$	$eP_{tot}^+ eP_{tot}^-$	$eP_1^+ eP_1^- eP_2^+ eP_2^- eP_3^+ eP_3^- eP_{tot}^+ eP_{tot}^-$
		eQ	$eQ_1^{i+} eQ_1^{c+}$ $eQ_1^{i-} eQ_1^{c-}$	$eQ_{tot}^{i+} eQ_{tot}^{c+}$ $eQ_{tot}^{i-} eQ_{tot}^{c-}$	$eQ_1^{i+} eQ_1^{c+} eQ_2^{i+} eQ_2^{c+} eQ_3^{i+} eQ_3^{c+} eQ_{tot}^{i+} eQ_{tot}^{c+}$ $eQ_1^{i-} eQ_1^{c-} eQ_2^{i-} eQ_2^{c-} eQ_3^{i-} eQ_3^{c-} eQ_{tot}^{i-} eQ_{tot}^{c-}$
		eS	$eS_1^+ eS_1^-$	$eS_{tot}^+ eS_{tot}^-$	$eS_1^+ eS_1^- eS_2^+ eS_2^- eS_3^+ eS_3^- eS_{tot}^+ eS_{tot}^-$
	Power factor	Pf	$PF_1^{i+} PF_1^{c+}$ $PF_1^{i-} PF_1^{c-}$	$PF_{tot}^{i+} PF_{tot}^{c+} PF_{tot}^{i-} PF_{tot}^{c-}$	$PF_1^{i+} PF_1^{c+} PF_2^{i+} PF_2^{c+} PF_3^{i+} PF_3^{c+} PF_{tot}^{i+} PF_{tot}^{c+}$ $PF_1^{i-} PF_1^{c-} PF_2^{i-} PF_2^{c-} PF_3^{i-} PF_3^{c-} PF_{tot}^{i-} PF_{tot}^{c-}$
		DPF	$DPF_1^{i+} DPF_1^{c+}$ $DPF_1^{i-} DPF_1^{c-}$	-	$DPF_1^{i+} DPF_1^{c+} DPF_2^{i+} DPF_2^{c+} DPF_3^{i+} DPF_3^{c+}$ $DPF_1^{i-} DPF_1^{c-} DPF_2^{i-} DPF_2^{c-} DPF_3^{i-} DPF_3^{c-}$
	Flicker	Pst (1min)	Pst_{1min1}	$Pst_{1min12} Pst_{1min23} Pst_{1min31}$	$Pst_{1min1} Pst_{1min2} Pst_{1min3}$
		Pst (10min)	Pst_1	$Pst_{12} Pst_{23} Pst_{31}$	$Pst_1 Pst_2 Pst_3$
Plt (2h)		Plt_1	$Plt_{12} Plt_{23} Plt_{31}$	$Plt_1 Plt_2 Plt_3$	
Unbalance	%	-	$\bar{u} \bar{i}$	$u^0 i^0 \bar{u} \bar{i}$	
Harmonics	Uh _{1÷50}	$U_{1h_{1÷50}} U_{Nh_{1÷50}}$	$U_{12h_{1÷50}} U_{23h_{1÷50}} U_{31h_{1÷50}}$	$U_{1h_{1÷50}} U_{2h_{1÷50}} U_{3h_{1÷50}} U_{Nh_{1÷50}}$	
	Ih _{1÷50}	$I_{1h_{1÷50}} I_{Nh_{1÷50}}$	$I_{1h_{1÷50}} I_{2h_{1÷50}} I_{3h_{1÷50}}$	$I_{1h_{1÷50}} I_{2h_{1÷50}} I_{3h_{1÷50}} I_{Nh_{1÷50}}$	
	Uih _{1÷50}	$U_{1ih_{1÷50}} U_{Nih_{1÷50}}$	$U_{12ih_{1÷50}} U_{23ih_{1÷50}} U_{31ih_{1÷50}}$	$U_{1ih_{1÷50}} U_{2ih_{1÷50}} U_{3ih_{1÷50}} U_{Nih_{1÷50}}$	
	Iih _{1÷50}	$I_{1ih_{1÷50}} I_{Nih_{1÷50}}$	$I_{1ih_{1÷50}} I_{2ih_{1÷50}} I_{3ih_{1÷50}}$	$I_{1ih_{1÷50}} I_{2ih_{1÷50}} I_{3ih_{1÷50}} I_{Nih_{1÷50}}$	

5 Theory and internal operation

This section contains basic theory of measuring functions and technical information of the internal operation of the PowerQ4 Plus instrument, including descriptions of measuring methods and logging principles.

5.1 Measurement methods

5.1.1 Measurement aggregation over time intervals

Standard compliance: IEC 61000-4-30 Class A (Section 4.4)

The basic measurement time interval for:

- Voltage
- Current
- Active, reactive and apparent power
- Harmonics
- Unbalance

is a 10-cycle time interval. The 10-cycle measurement is resynchronized on each **Interval** tick according to the IEC 61000-4-30 Class A. Measurement methods are based on the digital sampling of the input signals, synchronised to the fundamental frequency. Each input (4 voltages and 4 currents) is simultaneously sampled 1024 times in 10 cycles.

5.1.2 Voltage measurement (magnitude of supply voltage)

Standard compliance: IEC 61000-4-30 Class A (Section 5.2)

All voltage measurements represent RMS values of 1024 samples of the voltage magnitude over a 10-cycle time interval. Every 10 interval is contiguous, and not overlapping with adjacent 10 intervals.

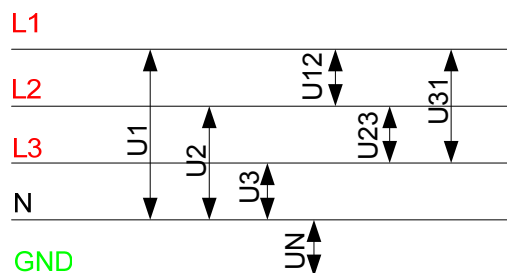

Figure 5.1: Phase and Phase-to-phase (line) voltage

Voltage values are measured according to the following equation:

Phase voltage:

$$U_p = \sqrt{\frac{1}{1024} \sum_{j=1}^{1024} u_{p,j}^2} \quad [V], p: 1,2,3,N \quad (1)$$

$$\text{Line voltage: } U_{pg} = \sqrt{\frac{1}{1024} \sum_{j=1}^{1024} (u_{p_j} - u_{g_j})^2} \text{ [V], pg: 12,23,31} \quad (2)$$

$$\text{Phase voltage crest factor: } Cf_{Up} = \frac{U_{pPk}}{U_p}, p: 1,2,3,N \quad (3)$$

$$\text{Line voltage crest factor: } Cf_{Upg} = \frac{U_{pgPk}}{U_{pg}}, pg: 12, 23, 31 \quad (4)$$

The instrument has internally 3 voltage measurement ranges. Middle voltage (MV) and high voltage (HV) systems can be measured on lowest voltage range with assistance of voltage transformers. Its voltage factor should be entered into Voltage ratio: 1:1 variable in CONNECTION SETUP menu.

5.1.3 Current measurement (magnitude of supply current)

All current measurements represent RMS values of the 1024 samples of current magnitude over a 10-cycle time interval. Each 10-cycle interval is contiguous and non-overlapping.

Current values are measured according to the following equation:

$$\text{Phase current: } I_p = \sqrt{\frac{1}{1024} \sum_{j=1}^{1024} I_{p_j}^2} \text{ [A], } p: 1,2,3,N \quad (5)$$

$$\text{Phase current crest factor: } Ip_{cr} = \frac{Ip_{max}}{Ip}, p: 1,2,3,N \quad (6)$$

The instrument has internally two current ranges: 10% and 100% range of nominal transducer current. Additionally Smart current clamps models offer few measuring ranges and automatic detection.

5.1.4 Frequency measurement

Standard compliance: IEC 61000-4-30 Class A (Section 5.1)

During RECORDING with aggregation time Interval: ≥10 sec frequency reading is obtained every 10 s. As power frequency may not be exactly 50 Hz within the 10 s time clock interval, the number of cycles may not be an integer number. The fundamental frequency output is the ratio of the number of integral cycles counted during the 10 s time clock interval, divided by the cumulative duration of the integer cycles. Harmonics and interharmonics are attenuated with 2-pole low pass filter in order to minimize the effects of multiple zero crossings.

The measurement time intervals are non-overlapping. Individual cycles that overlap the 10 s time clock are discarded. Each 10 s interval begin on an absolute 10 s time clock, with uncertainty as specified in section 6.2.17.

For RECORDING with aggregation time Interval: <10 sec and on-line measurements, frequency reading is obtained from 10 cycles, in order to decrease instrument response time. The frequency is ratio of 10 cycles, divided by the duration of the integer cycles.

Frequency measurement is *performed* on chosen Synchronization channel, in CONNECTION SETUP menu.

5.1.5 Phase power measurements

Standard compliance: IEEE STD 1459-2000 (Section 3.2.2.1; 3.2.2.2)
IEC 61557-12 (Annex A)

All active power measurements represent RMS values of the 1024 samples of instantaneous power over a 10-cycle time interval. Each 10-cycle interval is contiguous and non-overlapping.

Phase active power:

$$P_p = \frac{1}{1024} \sum_{j=1}^{1024} p_{pj} = \frac{1}{1024} \sum_{j=1}^{1024} U_{pj} * I_{pj} \quad [\text{W}], p: 1,2,3 \quad (7)$$

Apparent and reactive power, power factor and displacement power factor ($\text{Cos } \varphi$) are calculated according to the following equations:

$$\text{Phase apparent power: } S_p = U_p * I_p \quad [\text{VA}], p: 1,2,3 \quad (8)$$

$$\text{Phase reactive power: } Q_p = \text{Sign}(Q_p) \cdot \sqrt{S_p^2 - P_p^2} \quad [\text{VAr}], p: 1,2,3 \quad (9)$$

$$\text{Sign of reactive power: } \text{Sign}(Q_p) = \begin{cases} +1, \varphi_p \in [0^\circ - 180^\circ] \\ -1, \varphi_p \in [0^\circ - 180^\circ] \end{cases} \quad p: 1,2,3 \quad (10)$$

$$\text{Phase power factor: } PF_p = \frac{P_p}{S_p}, p: 1,2,3 \quad (11)$$

$$\text{Cos } \varphi \text{ (DPF): } \text{Cos } \varphi_p = \text{Cos } \varphi_{u_p} - \text{Cos } \varphi_{i_p}, p: 1,2,3 \quad (12)$$

5.1.6 Total power measurements

Standard compliance: IEEE STD 1459-2000 (Section 3.2.2.2; 3.2.2.6)
IEC 61557-12 (Annex A)

Total active, reactive and apparent power and total power factor are calculated according to the following equation:

$$\text{Total active power: } P_t = P_1 + P_2 + P_3 \quad [\text{W}], \quad (13)$$

$$\text{Total reactive power (vector): } Q_t = Q_1 + Q_2 + Q_3 \quad [\text{VAr}], \quad (14)$$

$$\text{Total apparent power (vector): } S_t = \sqrt{(P_t^2 + Q_t^2)} \quad [\text{VA}], \quad (15)$$

Total power factor (vector): $PF_{tot} = \frac{Pt}{St}$. (16)

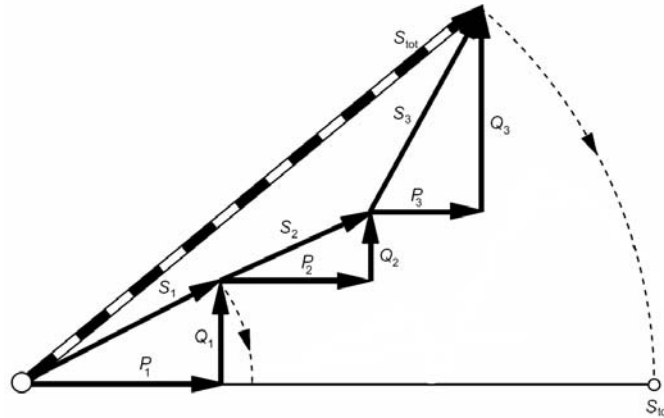

Figure 5.2: Vector representation of total power calculus

5.1.7 Energy

Standard compliance: IEC 61557-12 (Annex A)

Energy counters are linked to RECORDER functionality. Energy counters measure energy only when RECORDER is active. After power off/on procedure and before start of recording, all counters are cleared.

Instrument use 4-quadrant measurement technique which use two active energy counters (eP⁺, eP⁻) and two reactive (eQ⁺, eQ⁻), as shown on bellow.

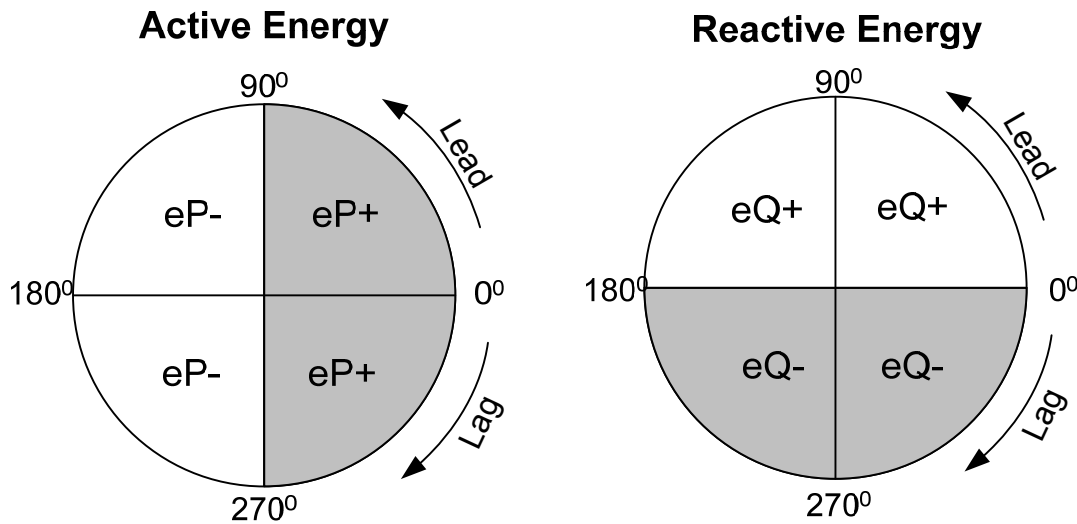

Figure 5.3: Energy counters and quadrant relationship

Instrument has 3 different counters sets:

1. Total counters **TOT.EN** are intended for measuring energy over a complete recording. When recorder starts it sums the energy to existent state of the counters.
2. Last integration period **LST.IP** counter measures energy during recording over last interval. It is calculated at end of each interval.

3. Current integration period **CUR.IP** counter measures energy during recording over current time interval.

5.1.8 Harmonics and interharmonics

Standard compliance: IEC 61000-4-30 Class A (Section 5.7)
IEC 61000-4-7 Class I

Calculation called fast Fourier transformation (FFT) is used to translate AD converted input signal to sinusoidal components. The following equation describes relation between input signal and its frequency presentation.

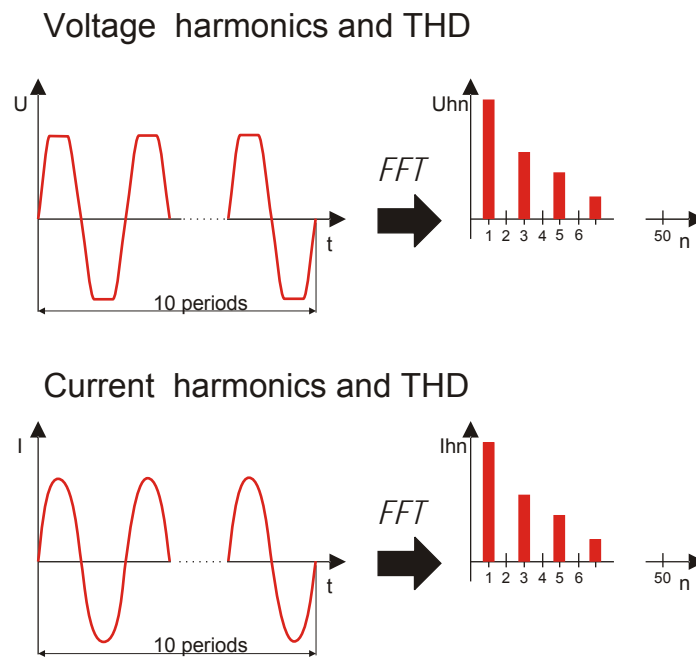

Figure 5.4: Current and voltage harmonics

$$u(t) = c_0 + \sum_{k=1}^{512} c_k \sin\left(\frac{k}{10} \cdot 2\pi f_1 t + \varphi_k\right) \quad (17)$$

f_1 – frequency of signal fundamental (in example: 50 Hz)

c_0 – DC component

k – ordinal number (order of the spectral line) related to the frequency basis $f_{c1} = \frac{1}{T_N}$

T_N – is the width (or duration) of the time window ($T_N = N \cdot T_1$; $T_1 = 1/f_1$). Time window is that time span of a time function over which the Fourier transformation is performed.

c_k – is the amplitude of the component with frequency $f_{ck} = \frac{k}{10} f_1$

φ_k – is the phase of the component c_k

$U_{c,k}$ – is the RMS value of component c_k

Phase voltage and current harmonics are calculated as RMS value of harmonic subgroup (sg): square root of the sum of the squares of the RMS value of a harmonic and the two spectral components immediately adjacent to it.

$$\text{n-th voltage harmonic: } U_p h_n = \sqrt{\sum_{k=-1}^1 U_{C,(10-n)+k}^2} \quad p: 1,2,3 \quad (18)$$

$$\text{n-th current harmonic: } I_p h_n = \sqrt{\sum_{k=-1}^1 I_{C,(10-n)+k}^2} \quad p: 1,2,3 \quad (19)$$

Total harmonic distortion is calculated as ratio of the RMS value of the harmonic subgroups to the RMS value of the subgroup associated with the fundamental:

$$\text{Total voltage harmonic distortion: } THD_{U_p} = \sqrt{\sum_{n=2}^{40} \left(\frac{U_p h_n}{U_p h_1} \right)^2}, \quad p: 1,2,3 \quad (20)$$

$$\text{Total current harmonic distortion: } THD_{I_p} = \sqrt{\sum_{n=2}^{40} \left(\frac{I_p h_n}{I_p h_1} \right)^2}, \quad p: 1,2,3 \quad (21)$$

Spectral component between two harmonic subgroups are used for interharmonics assessment. Voltage and current interharmonic subgroup of n-th order is calculated using RSS (root sum square) principle:

$$\text{n-th voltage interharmonic: } U_p i h_n = \sqrt{\sum_{k=2}^8 U_{C,(10-n)+k}^2} \quad p: 1,2,3 \quad (22)$$

$$\text{n-th current interharmonic: } I_p i h_n = \sqrt{\sum_{k=2}^8 I_{C,(10-n)+k}^2} \quad p: 1,2,3 \quad (23)$$

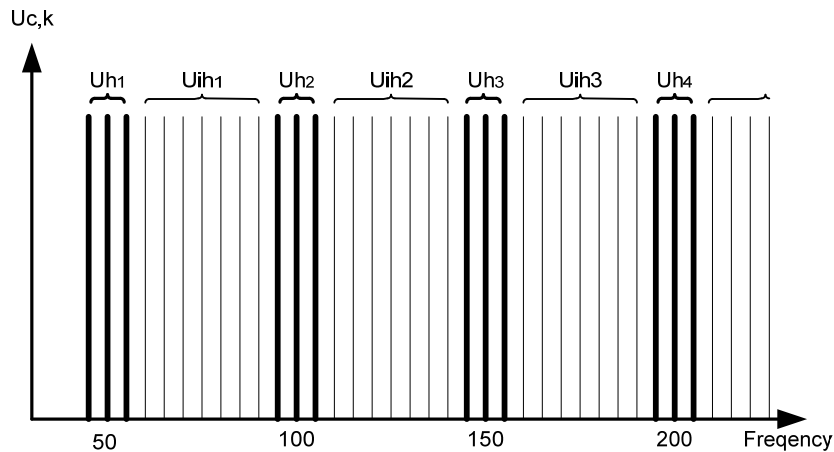

Figure 5.5: Illustration of harmonics / interharmonics subgroup for 50 Hz supply

5.1.9 Signalling

Standard compliance: IEC 61000-4-30 Class A (Section 5.10)

Signalling voltage is calculated on a FFT spectrum of a 10-cycle interval. Value of mains signalling voltage is measured as:

- RMS value of a single frequency bin if signalling frequency is equal to spectral bin frequency, or
- RSS value of four neighboring frequency bins if signalling frequency differs from the power system bin frequency (for example, a ripple control signal with frequency value of 218,1 Hz in a 50 Hz power system is measured based on the RMS values of 210, 215, 220 and 225 Hz bins).

Mains signalling value calculated every 10 cycle interval are used in alarm and recording procedures. However, for EN50160 recording, results are aggregated additionally on a 3s intervals. Those values are used for confronting with limits defined in standard.

5.1.10 Flicker

Standard compliance: IEC 61000-4-30 Class A (Section 5.3)
IEC 61000-4-15

Flicker is a visual sensation caused by unsteadiness of a light. The level of the sensation depends on the frequency and magnitude of the lighting change and on the observer.

Change of a lighting flux can be correlated to a voltage envelope on figure bellow.

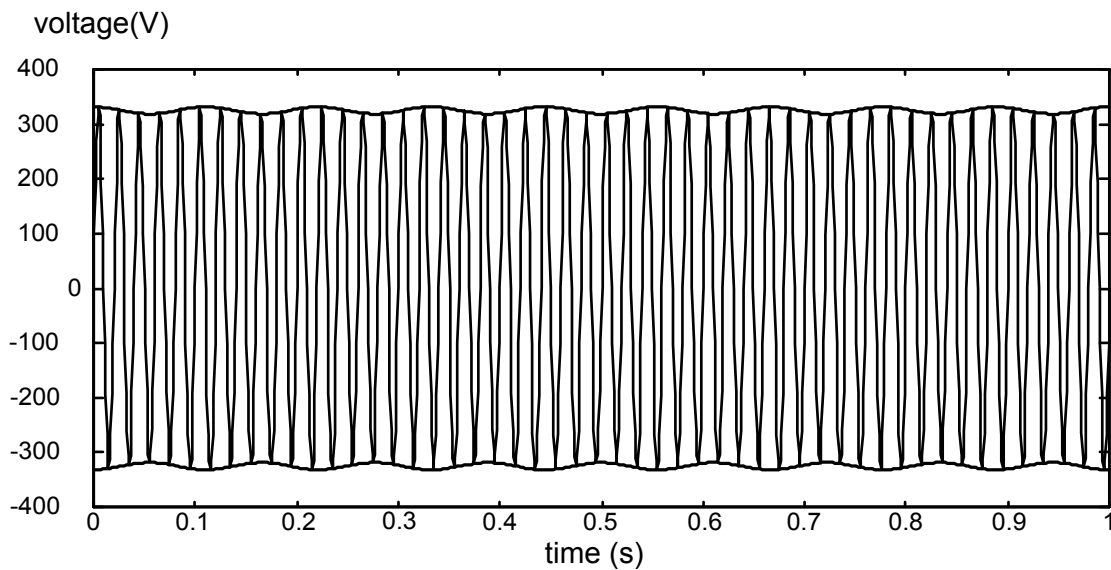

Figure 5.6: Voltage fluctuation

Flickers are measured in accordance with standard IEC 61000-4-15 “Flicker meter-functional and design specifications”. It defines the transform function based on a 230V/60W lamp-eye-brain chain response. That function is a base for flicker meter implementation and is presented on figure bellow.

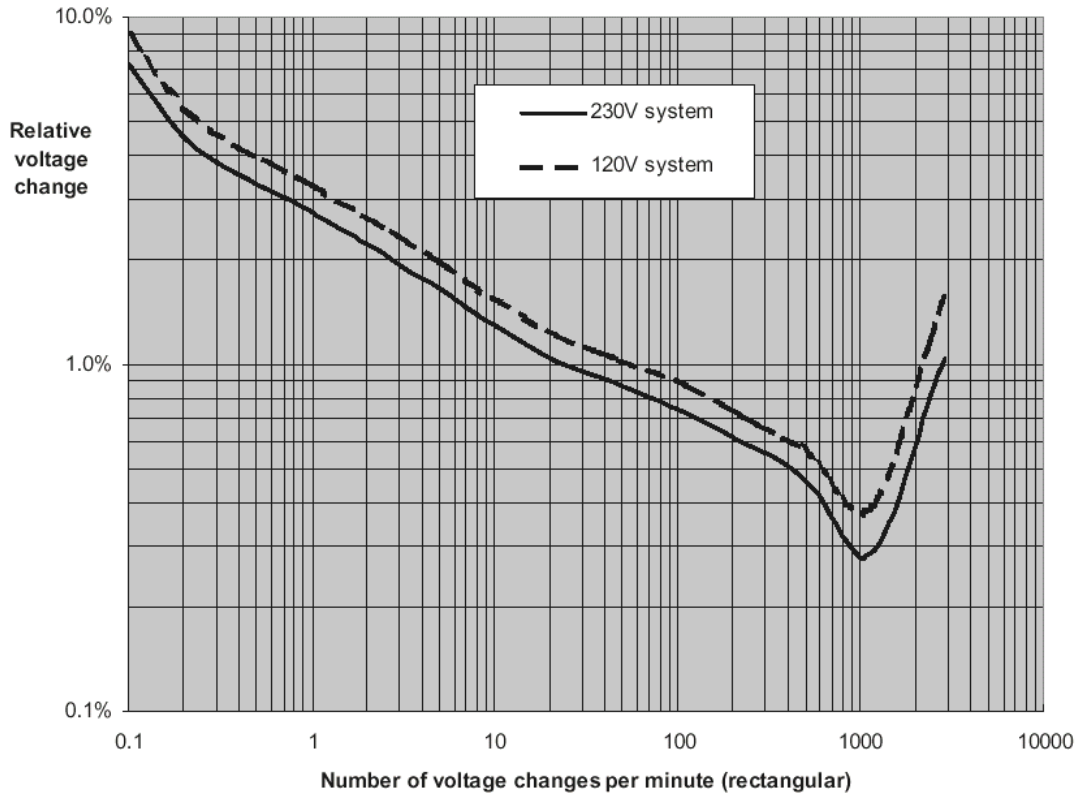

Figure 5.7: Curve of equal severity ($P_{st}=1$) for rectangular voltage changes on LV power supply systems

$P_{stp1min}$ – is a short flicker estimation based on 1-minute interval. It is calculated as running average and is used to get quick preview of 10 minutes.

P_{stp} – short term flicker is calculated according to IEC 61000-4-15

P_{ltp} – long term flicker is calculated according to the following equation:

$$P_{ltp} = \sqrt[3]{\frac{\sum_{i=1}^N P_{st_i}^3}{N}} \quad p: 1,2,3 \quad (24)$$

5.1.11 Voltage and current unbalance

Standard compliance: IEC 61000-4-30 Class A (Section 5.7.1)

The supply voltage unbalance is evaluated using the method of symmetrical components. In addition to the positive sequence component \vec{U}^+ , under unbalanced conditions there also exists negative sequence component \vec{U}^- and zero sequence component \vec{U}_0 . These quantities are calculated according to the following equations:

$$\begin{aligned} \vec{U}^+ &= \frac{1}{3}(\vec{U}_1 + a\vec{U}_2 + a^2\vec{U}_3) \\ \vec{U}_0 &= \frac{1}{3}(\vec{U}_1 + \vec{U}_2 + \vec{U}_3), \\ \vec{U}^- &= \frac{1}{3}(\vec{U}_1 + a^2\vec{U}_2 + a\vec{U}_3), \end{aligned} \quad (25)$$

where $a = \frac{1}{2} + \frac{1}{2}j\sqrt{3} = 1e^{j120^\circ}$.

For unbalance calculus, instrument use the fundamental component of the voltage input signals (U_1, U_2, U_3), measured over a 10-cycle time interval.

The negative sequence ratio u^- , expressed as a percentage, is evaluated by:

$$u^-(\%) = \frac{U^-}{U^+} \times 100 \quad (26)$$

The zero sequence ratio u^0 , expressed as a percentage, is evaluated by:

$$u^0(\%) = \frac{U^0}{U^+} \times 100 \quad (27)$$

Note: In 3W systems zero sequence components U_0 and I_0 are by definition zero.

The supply current unbalance is evaluated in same fashion.

5.1.12 Voltage events

Voltage dips (U_{Dip}), swells (U_{Swell}), minimum ($U_{Rms(1/2)Min}$) and maximum ($U_{Rms(1/2)Max}$) measurement method

Standard compliance: IEC 61000-4-30 Class A (Section 5.4.1)

The basic measurement for event is $U_{Rms(1/2)}$.

$U_{Rms(1/2)}$ is value of the RMS voltage measured over 1 cycle, commencing at a fundamental zero crossing and refreshed each half-cycle.

The cycle duration for $U_{Rms(1/2)}$ depends on the frequency, which is determined by the last 10-cycle frequency measurement. The $U_{Rms(1/2)}$ value includes, by definition, harmonics, interharmonics, mains signalling voltage, etc.

Voltage dip

Standard compliance: IEC 61000-4-30 Class A (Section 5.4.2)

The dip threshold is a percentage of Nominal voltage defined in EVENT SETUP menu.

The dip threshold can be set by the user according to the use. Instrument event evaluation depends on Connection type:

- On single-phase systems, a voltage dip begins when the $U_{Rms(1/2)}$ voltage falls below the dip threshold, and ends when the $U_{Rms(1/2)}$ voltage is equal to or above the dip threshold plus the 2% of hysteresis voltage (see Figure 5.8)
- On three-phase systems two different evaluation techniques can be used for evaluation simultaneously:
 - a dip begins when the $U_{Rms(1/2)}$ voltage of one or more channels is below the dip threshold and ends when the $U_{Rms(1/2)}$ voltage on all measured channels is equal to or above the dip threshold plus the 2% of hysteresis voltage.
 - a voltage dip begins when the $U_{Rms(1/2)}$ voltage of one channel falls below the dip threshold, and ends when the $U_{Rms(1/2)}$ voltage is equal to or above the dip threshold plus the 2% of hysteresis voltage, on the same phase.

A voltage dip is characterized by a pair of data: residual voltage U_{Dip} and dip duration:

- U_{Dip} is the residual voltage, the lowest $U_{Rms(1/2)}$ value measured on any channel during the dip.
- The start time of a dip is time stamped with the time of the start of the $U_{Rms(1/2)}$ of the channel that initiated the event, and the end time of the dip is time stamped

with the time of the end of the $U_{Rms(1/2)}$ that ended the event, as defined by the threshold.

- The duration of a voltage dip is the time difference between the start time and the end time of the voltage dip.

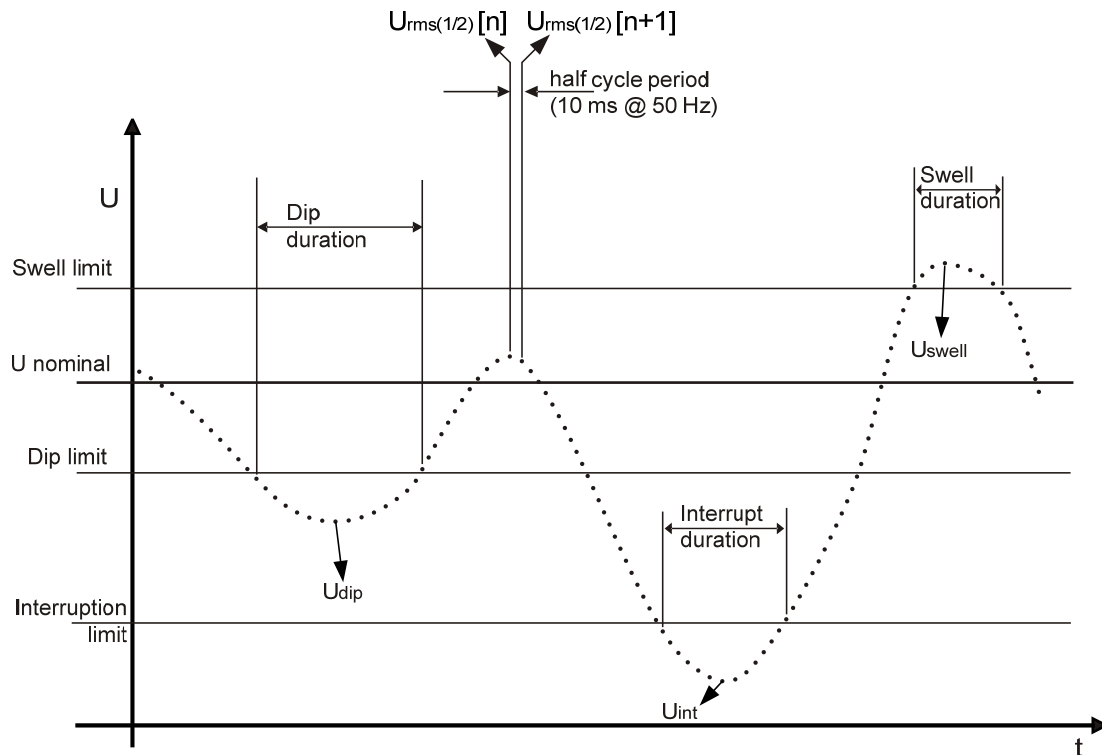

Figure 5.8 Voltage events definition

Voltage swell

Standard compliance: IEC 61000-4-30 Class A (Section 5.4.3)

The swell threshold is a percentage of nominal voltage defined in Voltage events setup menu. The swell threshold can be set by the user according to the use. Instrument permits swell evaluation:

- on single-phase systems, a voltage swell begins when the $U_{Rms(1/2)}$ voltage rises above the swell threshold, and ends when the U_{Rms} voltage is equal to or below the swell threshold plus the 2% of hysteresis voltage (see Figure 5.8),
- on three-phase systems two different evaluation techniques can be used for evaluation simultaneously:
 - A swell begins when the $U_{Rms(1/2)}$ voltage of one or more channels is above the swell threshold and ends when the $U_{Rms(1/2)}$ voltage on all measured channels is equal to or below the swell threshold plus the 2% of hysteresis voltage.
 - A swell begins when the $U_{Rms(1/2)}$ voltage of one channel rises above the swell threshold, and ends when the $U_{Rms(1/2)}$ voltage is equal to or below the swell threshold plus the 2% of hysteresis voltage, on the same phase.

A voltage swell is characterized by a pair of data: maximum swell voltage magnitude, and duration:

- U_{swell} – maximum swell magnitude voltage is the largest $U_{\text{Rms}(1/2)}$ value measured on any channel during the swell.
- The start time of a swell is time stamped with the time of the start of the $U_{\text{Rms}(1/2)}$ of the channel that initiated the event and the end time of the swell is time stamped with the time of the end of the $U_{\text{Rms}(1/2)}$ that ended the event, as defined by the threshold.
- The duration of a voltage swell is the time difference between the beginning and the end of the swell.

Voltage interrupt

Standard compliance: IEC 61000-4-30 Class A (Section 5.5)

Measuring method for voltage interruptions detection is same as for dips and swells, and is described in previous sections.

The interrupt threshold is a percentage of nominal voltage defined in Voltage events setup menu. The interrupt threshold can be set by the user according to the use. Instrument permits interrupt evaluation:

- On single-phase systems, a voltage interruption begins when the $U_{\text{Rms}(1/2)}$ voltage falls below the voltage interruption threshold and ends when the $U_{\text{Rms}(1/2)}$ value is equal to, or greater than, the voltage interruption threshold plus the hysteresis (see Figure 5.8),
- on polyphase systems two different evaluation techniques can be used for evaluation simultaneously:
 - a voltage interruption begins when the $U_{\text{Rms}(1/2)}$ voltages of all channels fall below the voltage interruption threshold and ends when the $U_{\text{Rms}(1/2)}$ voltage on any one channel is equal to, or greater than, the voltage interruption threshold plus the hysteresis.
 - a voltage interrupt begins when the $U_{\text{Rms}(1/2)}$ voltage of one channel fall below the interrupt threshold, and ends when the $U_{\text{Rms}(1/2)}$ voltage is equal to or above the interrupt threshold plus the 2% of hysteresis voltage, on the same phase.

A voltage interrupt is characterized by a pair of data: minimal interrupt voltage magnitude, and duration:

- U_{int} – minimum interrupt magnitude voltage is the lowers $U_{\text{Rms}(1/2)}$ value measured on any channel during the interrupt.
- The start time of a interrupt is time stamped with the time of the start of the $U_{\text{Rms}(1/2)}$ of the channel that initiated the event, and the end time of the interrupt is time stamped with the time of the end of the $U_{\text{Rms}(1/2)}$ that ended the event, as defined by the threshold.
- The duration of a voltage dip is the time difference between the start time and the end time of the voltage dip.

5.1.13 Alarms

Generally alarm can be seen as an event on arbitrary quantity. Alarms are defined in alarm table (see section 3.16.3 for alarm table setup). The basic measurement time interval for: voltage, current, active, reactive and apparent power, harmonics and unbalance alarms is a 10-cycle time interval. Flicker alarms are evaluated according to the flicker algorithm ($P_{\text{st}1\text{min}} > 1\text{min}$, $P_{\text{st}} > 10\text{min}$, $P_{\text{It}} > 10\text{min}$).

Each alarm has attributes described in table below. Alarm occurs when 10-cycle measured value on phases defined as **Phase**, cross **Threshold value** according to defined **Trigger slope**, minimally for **Minimal duration** value.

Table 5.1: Alarm definition parameters

Quantity	<ul style="list-style-type: none"> • Voltage • Current • Frequency • Active, reactive and apparent power • Harmonics and interharmonics • Unbalance • Flickers • Signalling
Phase	L1, L2, L3, L12, L23, L31, All, Tot
Trigger slope	< - Fall , > - Rise
Threshold value	[Number]
Minimal duration	200ms ÷ 10min

Each captured alarm is described by the following parameters:

Table 5.2: Alarm signatures

Date	Date when selected alarm has occurred
Start	Alarm start time - when first value cross threshold.
Phase	Phase on which alarm occurred
Level	Minimal or maximal value in alarm
Duration	Alarm duration.

5.1.14 Data aggregation in GENERAL RECORDING

Standard compliance: IEC 61000-4-30 Class S (Section 4.5.3)

Time aggregation period (IP) during recording is defined with parameter Interval: x min in RECORDER menu.

A new recording interval commence after previous interval run out, at the beginning of the next 10 cycle time interval. The data for the IP time interval are aggregated from 10-cycle time intervals, according to the figure below. The aggregated interval is tagged with the absolute time. The time tag is the time at the conclusion of the interval. There is no gap or overlap, during recording, as illustrated on figure below.

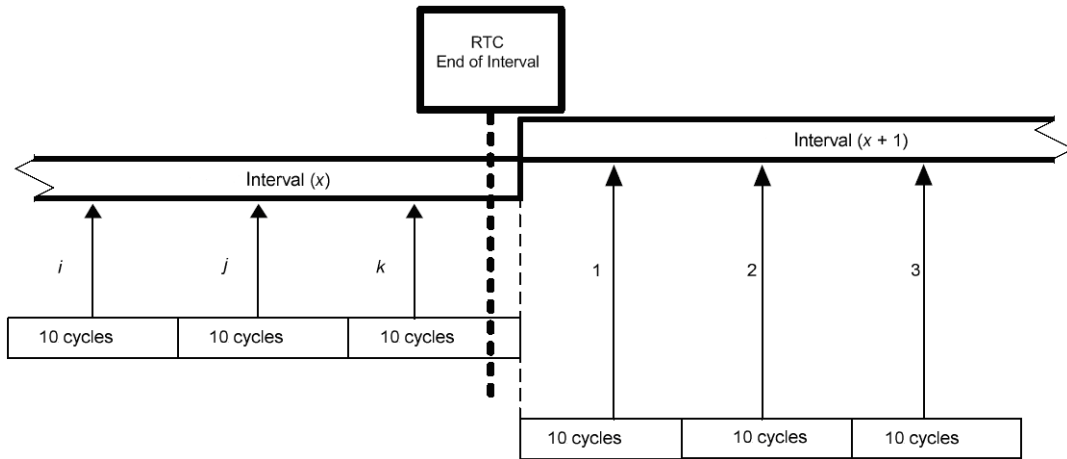

Figure 5.9: Synchronization and aggregation of 10 cycle intervals

For each aggregation interval instrument computes average value for measured quantity. Depending from the quantity, this can be RMS (root means square) or arithmetical average. Equations for both averages are shown below.

RMS average
$$A_{RMS} = \sqrt{\frac{1}{N} \sum_{j=1}^N A_j^2}$$
 (28)

Where:

A_{RMS} – quantity average over given aggregation interval

A – 10-cycle quantity value

N – number of 10 cycles measurements per aggregation interval.

Arithmetic average:
$$A_{avg} = \frac{1}{N} \sum_{j=1}^N A_j$$
 (29)

Where:

A_{avg} – quantity average over given aggregation interval

A – 10-cycle quantity value

N – number of 10 cycles measurements per aggregation interval.

In the next table averaging method for each quantity is specified:

Table 5.3: Data aggregation methods

Group	Value	Aggregation method
Voltage	U_{Rms}	RMS
	THD_U	RMS
	U_{cf}	Arithmetic
Current	I_{Rms}	RMS
	THD_I	RMS
	I_{cf}	Arithmetic
Frequency	f	Arithmetic
Power	P	Arithmetic

	Q	Arithmetic
	S	Arithmetic
	PF	Arithmetic
	DPF (cos φ)	Arithmetic
Symmetry	U ⁺	RMS
	U ⁻	RMS
	U ⁰	RMS
	u-	RMS
	u0	RMS
	I ⁺	RMS
	I ⁻	RMS
	I ⁰	RMS
	i-	RMS
i0	RMS	
Harmonics	Uh ₁₊₅₀	RMS
	Ih ₁₊₅₀	RMS
Interharmonics	Uh ₁₊₅₀	RMS
	Ih ₁₊₅₀	RMS
Signalling	U _{Sig}	RMS

Parameter which will be recorded during recording session depends on **Connection** and **Synchronization** channel, as shown in Table 4.7. For each parameter:

- minimum,
- average,
- maximum,
- active average,

value is recorded per time-interval.

Note: In EN 50160 recording only average values are stored. In order to perform EN50160 recording with minimum and maximum values, use general type of recording and later convert it into EN50160 type of record by using Powerview v2.0 software. An *active average* value is calculated upon the same principle (arithmetic or RMS) as average value, but taking in account just measurements with “active” attribute set:

$$\text{RMS active average} \quad A_{RMSact} = \sqrt{\frac{1}{M} \sum_{j=1}^M A_j^2}; M \leq N \quad (30)$$

Where:

A_{RMSact} – quantity average over active part of given aggregation interval,

A – 10-cycle quantity value marked as “active”,

M – number of 10 cycles measurements with active value.

$$\text{Arithmetic active average:} \quad A_{avgact} = \frac{1}{M} \sum_{j=1}^M A_j; M \leq N \quad (31)$$

Where:

A_{avgact} – quantity average over active part of given aggregation interval,

A – 10-cycle quantity value in “active” part of interval,

M – number of 10 cycles measurements with active value.

Active attribute for particular quantity is set if:

- Phase/line RMS value is greater than lower limit of a measuring range (details in technical specification): voltage and current effective value, harmonics and THD, voltage flicker.
- Type of a load coincides with two- or four-quadrant area (details in *Power and energy recording*): active, reactive and apparent power, power factor and displacement power factor.

Frequency and unbalance measurement are always considered as active values for recording.

Table below show number of signals for each parameter group in RECORDER.

Table 5.4: Total number of recorded quantities

	1W	3W	4W
U,I,f	13 quantities 52 values per interval	20 quantities 80 values per interval.	35 quantities 140 values per interval.
Power & Energy	16 quantities 64 values per interval	12 quantities 48 values per interval	60 quantities 240 values per interval
Flicker	3 quantities 12 values per interval	9 quantities 36 values per interval	9 quantities 36 values per interval
Symmetry	–	2 quantities 8 values per interval	4 quantities 16 values per interval
Harmonics	202 quantities 800	303 quantities 1212 values per interval	416 quantities 1628 values per interval
Interharmonics	202 quantities 800	303 quantities 1212 values per interval	416 quantities 1628 values per interval
Total	235	347	524

Power and energy recording

Active power is divided into two parts: import (positive-motor) and export (negative-generator). Reactive power and power factor are divided into four parts: positive inductive (+i), positive capacitive (+c), negative inductive (-i) and negative capacitive (-c).

Motor/generator and inductive/capacitive phase/polarity diagram is shown on figure below:

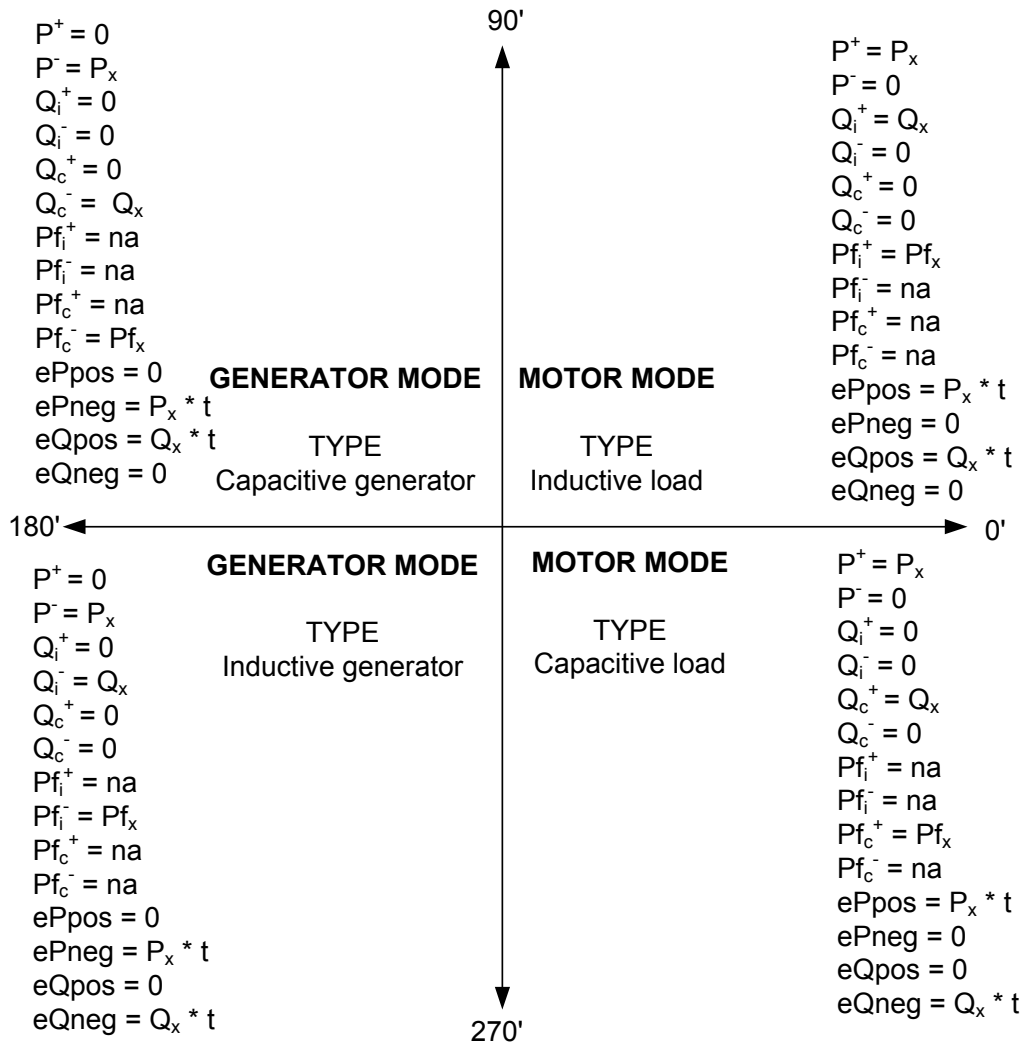

Figure 5.10: Motor/generator and inductive/capacitive phase/polarity diagram

5.1.15 Waveform snapshot

During measurement campaign PowerQ4 Plus has the ability to take waveform snapshot. This is particularly useful for storing temporary characteristics or network behavior. Snapshot stores all network signatures and samples of 10 cycles. Using MEMORY LIST function (see 3.10) or with PowerView v2.0 software, user can observe stored data.

5.1.16 Waveform record

Waveform record is consisted of a configurable number of consecutive Waveform snapshots. Waveform recorder starts when the preset trigger occurs. Storage buffer is divided into pre-trigger and post-trigger buffers. Pre and post-trigger buffers are composed of waveform snapshots taken before and after trigger occurrence. Several trigger sources are possible:

- Manual trigger - user manually triggers waveform recording.
- Voltage events – instrument start waveform recorder when voltage event occur.
- Alarms – instrument start waveform recorder when alarm from alarm list is detected.

- Voltage events and alarms - start waveform recorder when either voltage event or alarm occur

User can perform single or continuous waveform recordings. In continuous waveform recording, PowerQ4 Plus will automatically initialize next waveform recording upon completion of the previous one. That means that the following recording will be initialized only when the first one is being completely saved to the instrument data memory.

Note: Saving to the instrument data memory induces “dead time” between continuous waveform records. Dead time is proportional to record duration and number of selected recording signals, and usually takes few seconds.

5.1.17 Transient recorder

Transient record function is similar to waveform recorder: it stores a selectable set of pre- and post-trigger samples on trigger activation, with 10 times higher sampling rate. Recorder use envelope triggering. Trigger is activated if difference between two consecutive periods of input voltage signals, is greater than given limit. Transient recorder stores one cycle of mains signal.

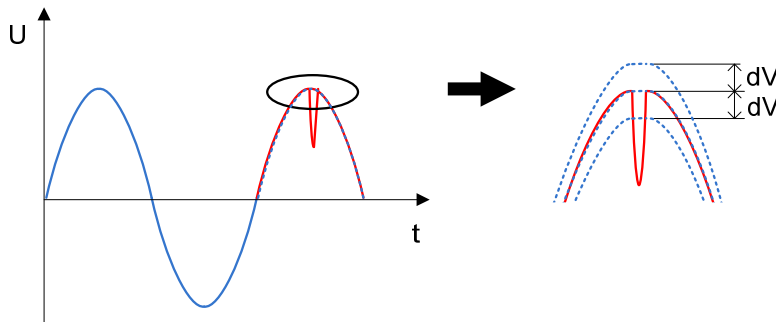

Figure 5.11: Transients trigger detection

Note: Saving to the instrument data memory induces dead time between consecutive transient records. Dead time is proportional to record duration and number of selected recording signals, and usually takes few seconds.

5.1.18 Inrush/Fast recorder

Inrush/Fast recorder is intended for analysis of voltage and current fluctuations during start of motor or other high power consumers. For current $I_{1/2Rms}$ value (half cycle period RMS current refreshed each half cycle) is measured, while for voltage $U_{Rms(1/2)}$ values (one cycle RMS voltage refreshed each half cycle) is measured for each interval. If user choose 10ms interval in INrrush/Fast recorder menu, then this measured values for half cycle will be also stored in record. If user choose larger interval 20ms, 100ms or 200ms, instrument average 2, 10 or 20 measurements and use it for further actions (triggering, recording). Inrush/Fast recorder starts when the preset trigger occurs.

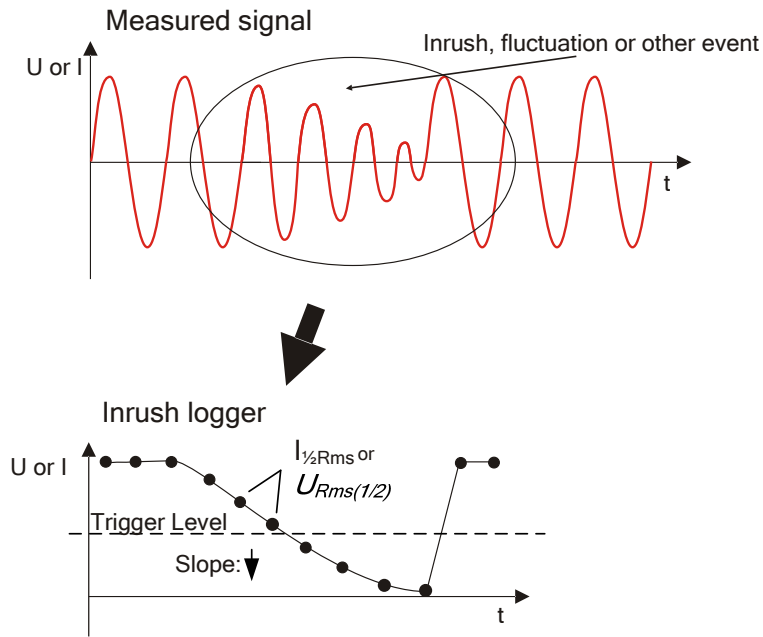
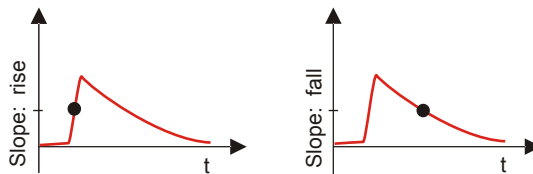

Figure 5.12: Inrush (waveform and RMS)

Storage buffer is divided into pre-buffer (measured values before trigger point) and post-buffer (measured values after trigger point).

Triggering



Input: I₁, I₂, I₃, I_N
 U₁, U₂, U₃, U_N - trigger channels
 Level: predefined TRMS value
 Slope: rise / fall / both

Pre-buffer and post-buffer

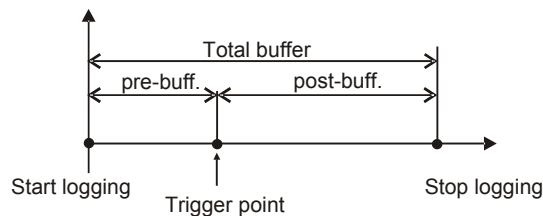

Pre-buffer: 0 to (Total buffer - 1)
 Pre-buffer is treated as negative time

Figure 5.13: Inrush triggering

User can choose to perform single or continuous inrush loggings. If continuous inrush logging is performed, PowerQ4 Plus will automatically initialize next inrush logging upon completion of the previous one. Two *initial* consecutive inrush loggings can be performed without “dead time” in between. The third inrush logging will be initialized only when the first one is being completely saved to the instrument data memory. Dead time is proportional to record duration and number of selected recording signals, and usually takes few seconds.

Note: Interval and triggering threshold are dependent. If user select Interval: 10ms, then instrument will trigger if value crosses the threshold for half cycle. If user select Interval: 200ms, then at least 20 successive half-cycle measurements, should cross the trigger value prior triggering.

5.2 EN 50160 Standard Overview

EN 50160 standard defines, describes and specifies the main characteristics of the voltage at a network user’s supply terminals in public low voltage and medium voltage distribution networks under normal operating conditions. This standard describe the limits or values within which the voltage characteristics can be expected to remain over the whole of the public distribution network and do not describe the average situation usually experienced by an individual network user. An overview of EN 50160 limits are presented on table below.

Table 5.5: EN 50160 standard overview

Supply phenomenon	voltage	Acceptable limits	Meas. Interval	Monitoring Period	Acceptance Percentage
Power frequency		49.5 ÷ 50.5 Hz 47.0 ÷ 52.0 Hz	10 s	1 Week	99,5% 100%
Supply voltage variations, U_{Nom}		230V ± 10% 230V +10% -15%	10 min	1 Week	95% 100%
Flicker severity Plt		Plt ≤ 1	2 h	1 Week	95%
Voltage Dips (≤1min)		10 to 1000 times (under 85% of U_{Nom})	10 ms	1 Year	100%
Short Interruptions (≤ 3min)		10 ÷ 100 times (under 1% of U_{Nom})	10 ms	1 Year	100%
Accidental long interruptions (> 3min)		10 ÷ 50 times (under 1% of U_{Nom})	10 ms	1 Year	100%
Voltage unbalance u-		0 ÷ 2 %, occasionally 3%	10 min	1 Week	95%
Total harm. distortion, THD _U		8%	10 min	1 Week	95%
Harmonic Voltages, U_{h_n}		See Table 5.6	10 min	1 Week	95%
Mains signalling		See Figure 5.15	2 s	1 Day	99%

5.2.1 Power frequency

The nominal frequency of the supply voltage shall be 50 Hz, for systems with synchronous connection to an interconnected system. Under normal operating conditions the mean value of the fundamental frequency measured over 10 s shall be within a range of:

50 Hz \pm 1 % (49,5 Hz .. 50,5 Hz) during 99,5 % of a year;
 50 Hz + 4 % / - 6 % (i.e. 47 Hz .. 52 Hz) during 100 % of the time.

5.2.2 Supply voltage variations

Under normal operating conditions, during each period of one week 95 % of the 10 min mean U_{Rms} values of the supply voltage shall be within the range of $U_{Nom} \pm 10$ %, and all U_{Rms} values of the supply voltage shall be within the range of $U_{Nom} + 10$ % / - 15 %.

5.2.3 Voltage dips (Indicative values)

Under normal operating conditions the expected number of voltage dips in a year may be from up to a few tens to up to one thousand. The majority of voltage dips have duration less than 1 s and a retained voltage greater than 40 %. However, voltage dips with greater depth and duration can occur infrequently. In some areas voltage dips with a retained voltage between 85 % and 90 % of U_{Nom} can occur very frequently as a result of the switching of loads in network users' installations.

5.2.4 Short interruptions of the supply voltage

Under normal operating conditions the annual occurrence of short interruptions of the supply voltage ranges from up to a few tens to up to several hundreds. The duration of approximately 70 % of the short interruptions may be less than one second.

5.2.5 Long interruptions of the supply voltage

Under normal operating conditions the annual frequency of accidental voltage interruptions longer than three minutes may be less than 10 or up to 50 depending on the area.

5.2.6 Supply voltage unbalance

Under normal operating conditions, during each period of one week, 95 % of the 10 min mean RMS values of the negative phase sequence component (fundamental) of the supply voltage shall be within the range 0 % to 2 % of the positive phase sequence component (fundamental). In some areas with partly single phase or two-phase connected network users' installations, unbalances up to about 3 % at three-phase supply terminals occur.

5.2.7 THD voltage and harmonics

Under normal operating conditions, during each period of one week, 95 % of the 10 min mean values of each individual harmonic voltage shall be less or equal to the value given in table below.

Moreover, THD_U values of the supply voltage (including all harmonics up to the order 40) shall be less than or equal to 8 %.

Table 5.6: Values of individual harmonic voltages at the supply

Odd harmonics				Even harmonics	
Not Multiples of 3		Multiples of 3		Order h	Relative voltage (U_N)
Order h	Relative voltage (U_N)	Order h	Relative voltage (U_N)		
5	6,0 %	3	5,0 %	2	2,0 %
7	5,0 %	9	1,5 %	4	1,0 %

11	3,5 %	15	0,5 %	6..24	0,5 %
13	3,0 %	21	0,5 %		
17	2,0 %				
19	1,5 %				
23	1,5 %				
25	1,5 %				

5.2.8 Interharmonic voltage

The level of interharmonics is increasing due to the development of frequency converters and similar control equipment. Levels are under consideration, pending more experience. In certain cases interharmonics, even at low levels, give rise to flicker (see 5.2.10), or cause interference in ripple control systems.

5.2.9 Mains signalling on the supply voltage

In some countries the public distribution networks may be used by the public supplier for the transmission of signals. Over 99 % of a day the 3 s mean of signal voltages shall be less than or equal to the values given in the following figure.

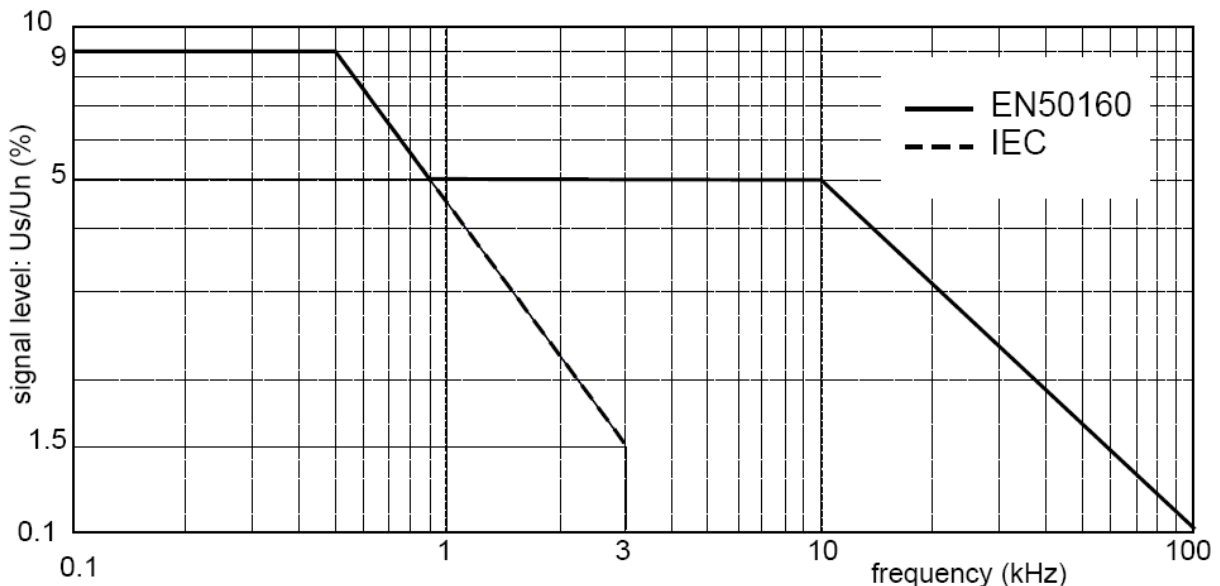

Figure 5.14: Mains Signalling voltage level limits according to EN50160

5.2.10 Flicker severity

Under normal operating conditions, in any period of one week the long term flicker severity caused by voltage fluctuation should be $P_{f \leq 1} \leq 1$ for 95 % of the time.

5.2.11 PowerQ4 Plus recorder setting for EN 50160 survey

PowerQ4 Plus are able to perform EN 50160 surveys on all values described in previous sections. In order to simplify procedure, PowerQ4 Plus has predefined recorder configuration (EN50160) for it. By default all current parameters (RMS, THD, etc.) are also included in survey, which can provide additional survey informations. Additionally, during voltage quality survey user can simultaneously record other parameters too, such as power, energy and current harmonics.

In order to collect voltage events during recording, **Include voltage events** option in recorder should be enabled. See section 3.16.2 for voltage events settings.

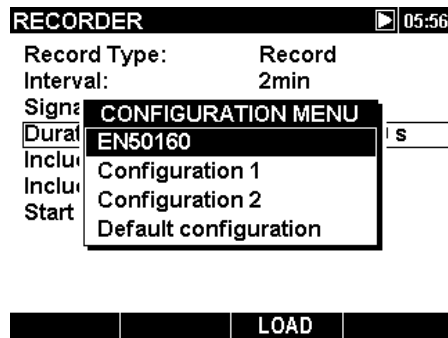

Figure 5.15: Predefined EN50160 recorder configuration

After recording is finished, EN 50160 survey is *performed* on PowerView v2.0 software. See PowerView v2.0 manual or details.

Note: In EN 50160 recording only average values are stored.

6 Technical specifications

6.1 General specifications

Working temperature range:	-10 °C ÷ +50 °C				
Storage temperature range:	-20 °C ÷ +70 °C				
Max. humidity:	95 % RH (0 °C ÷ 40 °C), non-condensing				
Pollution degree:	2				
<	double insulation				
Over voltage category:	CAT IV / 600 V; CAT III / 1000 V				
Protection degree:	IP 42				
Dimensions:	(220 x 115 x 90) mm				
Weight (without accessories):	0.65 kg				
Display:	Graphic liquid crystal display (LCD) with backlight, 320 x 200 dots.				
Memory:	8 MB Flash				
Batteries:	6 x 1.2 V NiMh rechargeable batteries type HR 6 (AA) Provide full operation for up to 15 hours*				
External DC supply:	12 V, 1.2 A min				
Maximum power consumption:	150 mA – without batteries 1 A – while charging batteries				
Battery charging time:	4 hours *				
Communication:	<table border="0"> <tr> <td>USB 1.0</td> <td>Standard USB Type B 2400 baud ÷ 921600 baud</td> </tr> <tr> <td>RS232</td> <td>8 pin PS/2 – type 2400 baud ÷ 115200 baud</td> </tr> </table>	USB 1.0	Standard USB Type B 2400 baud ÷ 921600 baud	RS232	8 pin PS/2 – type 2400 baud ÷ 115200 baud
USB 1.0	Standard USB Type B 2400 baud ÷ 921600 baud				
RS232	8 pin PS/2 – type 2400 baud ÷ 115200 baud				

* The charging time and the operating hours are given for batteries with a nominal capacity of 2500mAh

6.2 Measurements

Note: In order to get resolution and accuracy specified in this section, measuring data should be observed by PowerView v2.0 (Waveform Snapshot or On-Line View). PowerQ4 Plus display resolution is reduced due to screen space constraints and enhanced visibility of presented measurements (larger screen fonts and space between measurements).

6.2.1 General description

Max. input voltage (Phase – Neutral):	1000 V _{RMS}
Max. input voltage (Phase – Phase):	1730 V _{RMS}
Phase - Neutral input impedance:	6 MΩ
Phase – Phase input impedance:	6 MΩ
AD converter	16 bit 8 channels, simultaneous sampling
Reference temperature	23 °C ± 2 °C
Temperature influence	60 ppm/°C

NOTE: Instrument has 3 voltage ranges. Range has to be chosen according to the network nominal voltage, according to the table bellow.

Nominal phase voltage: U_{Nom}	Recommended Voltage range
50 V ÷ 110 V	Voltage Range 1: 50 V ÷ 110 V (L-N)
110 V ÷ 240 V	Voltage Range 2: 110 V ÷ 240 V (L-N)
240 V ÷ 1000 V	Voltage Range 3: 240 V ÷ 1000 V (L-N)

Nominal phase-to-phase voltage: U_{Nom}	Recommended Voltage range
86 V ÷ 190 V	Voltage Range 1: 86 V ÷ 190 V (L-L)
190 V ÷ 415 V	Voltage Range 2: 190 V ÷ 415 V (L-L)
415 V ÷ 1730 V	Voltage Range 3: 240 V ÷ 1730 V (L-L)

NOTE: Assure that all voltage clips are connected during measurement and logging period. Unconnected voltage clips are susceptible to EMI and can trigger false events. It is advisable to short them with instrument neutral voltage input.

6.2.2 Phase Voltages

U_{pRms} , p : [1, 2, 3, N], AC+DC

Nominal Voltage	Measuring Range	Resolution	Accuracy
50 ÷ 110 V	5.00 ÷ 99.99 V_{RMS} 100.0 ÷ 160.0 V_{RMS}	10 mV 100 mV	± 0.1 % · U_{NOM}
110 ÷ 240 V	11.0 ÷ 99.99 V_{RMS} 100.0 ÷ 360.0 V_{RMS}	10mV 100 mV	
240 ÷ 1000 V	24 ÷ 999.9 V_{RMS} 1000 ÷ 1500 V_{RMS}	100 mV 1 V	

$U_{pRms(1/2)}$ p : [1, 2, 3, N], AC+DC

Nominal Voltage	Measuring Range	Resolution	Accuracy
50 ÷ 110 V	5.00 ÷ 99.99 V_{RMS} 100.0 ÷ 160.0 V_{RMS}	10 mV 100 mV	± 0.2 % · U_{NOM}
110 ÷ 240 V	11.0 ÷ 99.99 V_{RMS} 100.0 ÷ 360.0 V_{RMS}	10mV 100 mV	
240 ÷ 1000 V	24 ÷ 999.9 V_{RMS} 1000 ÷ 1500 V_{RMS}	100 mV 1 V	

Cf_{Up} , p : [1, 2, 3, N], AC+DC

Measuring range	Resolution	Accuracy
1.00 ÷ 2.50	0.01	± 5 % · Cf_U

U_{pPk} : p : [1, 2, 3, N], AC+DC

Nominal Voltage	Measuring Range	Resolution	Accuracy
50 ÷ 110 V	5.00 ÷ 99.99 V _{pk} 100.0 ÷ 255.0 V _{pk}	10 mV 100 mV	± 0.1 % · U _{NOM}
110 ÷ 240 V	11.0 ÷ 99.99 V _{RMS} 100.0 ÷ 510.0 V _{RMS}	10 mV 100 mV	
240 ÷ 1000 V	24 ÷ 999.0 V _{RMS} 1000 ÷ 2250 V _{RMS}	100 mV 1 V	

6.2.3 Line voltages¹ **U_{pgRms} , pg : [12, 23, 31], AC+DC**

Nominal Voltage	Measuring Range	Resolution	Accuracy
86 V ÷ 190 V	8.00 ÷ 99.99 V _{RMS} 100.0 ÷ 260.0 V _{RMS}	10 mV 100 mV	± 0.5 % · U _{NOM}
190 V ÷ 415 V	19.0 ÷ 99.99 V _{RMS} 100.0 ÷ 622.0 V _{RMS}	10mV 100 mV	
415 V ÷ 1730 V	41.5 ÷ 999.9 V _{RMS} 1000 ÷ 2600 V _{RMS}	100 mV 1V	

 $U_{pRms(1/2)}$ pg : [12, 23, 31], AC+DC

Nominal Voltage	Measuring Range	Resolution	Accuracy
86 V ÷ 190 V	8.00 ÷ 99.99 V _{RMS} 100.0 ÷ 260.0 V _{RMS}	10 mV 100 mV	± 0.5 % · U _{NOM}
190 V ÷ 415 V	19.0 ÷ 99.99 V _{RMS} 100.0 ÷ 622.0 V _{RMS}	10mV 100 mV	
415 V ÷ 1730 V	41.5 ÷ 999.9 V _{RMS} 1000 ÷ 2600 V _{RMS}	100 mV 1V	

 Cf_{Upg} , pg : [12, 23, 31], AC+DC

Measuring range	Resolution	Accuracy
1.00 ÷ 2.50	0.01	± 5 % · Cf _U

 U_{pgPk} , pg : [12, 23, 31], AC+DC

Nominal Voltage	Measuring Range	Resolution	Accuracy
86 V ÷ 190 V	8.00 ÷ 99.99 V _{pk} 100.0 ÷ 442.0 V _{pk}	10 mV 100 mV	± 0.5 % · U _{NOM}
190 V ÷ 415 V	19.00 ÷ 99.99 V _{pk} 100.0 ÷ 622.0 V _{pk}	10mV 100 mV	
415 V ÷ 1730 V	41.5 ÷ 999.9 V _{pk} 1000 ÷ 2600 V _{pk}	100 mV 1V	

6.2.4 Current

Input impedance: 100 kΩ

¹ In Compliance with IEC 61000-4-30 Class S

I_{pRMS} , p : [1, 2, 3, N], AC+DC

Current range	Measuring range	Resolution	Accuracy	Crest factor
10%	50.0 ÷ 200.0 mV _{RMS}	100 µV	±0.25 % · U _{RMS}	min 1.5
100%	50.0 m ÷ 2.000 V _{RMS}		±0.25 % · U _{RMS}	

U_{RMS} – RMS voltage measured on current input

Peak value I_{pPk} , I_{NpK} , p : [1, 2, 3, 4, N], AC+DC

Current range	Measuring range	Resolution	Accuracy
10%	50.0 mV ÷ 280.0 mV _{PK}	100 µV	± 2 % · U _{PK}
100%	50.0 mV ÷ 3.000 V _{PK}		± 2 % · U _{PK}

U_{PK} – Peak voltage measured on current input

 $I_{p\frac{1}{2}RMS}$, p : [1, 2, 3, 4, N], AC+DC

Current range	Measuring range	Resolution	Accuracy	Crest factor
10%	20.0m ÷ 200.0 mV _{RMS}	100 µV	± 1 % · U _{RMS}	min 1.5
100%	20.0 m ÷ 2.000 V _{RMS}		± 1 % · U _{RMS}	

U_{RMS} – RMS (½) voltage measured on current input

Crest factor Cf_{Ip} , p : [1, 2, 3, 4, N], AC+DC

Measuring range	Resolution	Accuracy
1.00 ÷ 10.00	0.01	± 5 % · Cf _i

Current accuracy with clamps

Measurement accessory	Measuring range	Overall current accuracy	
A 1281	1000 A	100 A ÷ 1200 A	±0.4 % · I _{RMS}
	100 A	10 A ÷ 175 A	±0.4 % · I _{RMS}
	5 A	0.5 A ÷ 10 A	±0.4 % · I _{RMS}
	0.5 A	50 mA ÷ 1 A	±0.4 % · I _{RMS}
A 1227	3000 A	300 A ÷ 6000 A	±1.5 % · I _{RMS}
	300 A	30 A ÷ 600 A	±1.5 % · I _{RMS}
	30 A	3 A ÷ 60 A	±1.5 % · I _{RMS}
A 1033	1000 A	20 A ÷ 1000 A	±1.3 % · I _{RMS}
A 1122	5 A	100 mA ÷ 5 A	±1.3 % · I _{RMS}

Note: Overall accuracy is calculated as:

$$\text{System Uncertainty} = 1,15 \cdot \sqrt{\text{PowerQ4 Uncertainty}^2 + \text{Clamp Uncertainty}^2}$$

6.2.5 Frequency

Measuring range	Resolution	Accuracy
10.000 Hz ÷ 70.000 Hz	2 mHz	± 10 mHz

6.2.6 Flickermeter

Fl. Type	Measuring range	Resolution	Accuracy*
P _{It1min}	0.400 ÷ 4.000	0.001	± 5 % · P _{It1min}
P _{st}	0.400 ÷ 4.000		± 5 % · P _{st}
P _{It}	0.400 ÷ 4.000		± 5 % · P _{It}

* Guaranteed only in 49 Hz ÷ 51 Hz frequency range.

6.2.7 Power

		Measuring range (W, VAr, VA)	Resolution	Accuracy
Active power P*	Excluding clamps	0.000 k ÷ 999.9 M	4 digits	±0.5 % · P
	With A 1227 Flex clamps 3000A	0.000 k ÷ 999.9k		±1.8 % · P
	With A 1281 Multirange clamps 100 A	0.000 k ÷ 999.9k		±0.8 % · P
	With A 1033 1000 A	000.0 k ÷ 999.9 k		±1.6 % · P
Reactive power Q**	Excluding clamps	0.000 k ÷ 999.9 M	4 digits	±0.5 % · Q
	With A 1227 Flex clamps	0.000 k ÷ 999.9k		±1.8 % · Q
	With A 1281 Multirange clamps 100 A	0.000 k ÷ 999.9k		±0.8 % · Q
	With A 1033 1000 A	000.0 k ÷ 999.9 k		±1.6 % · Q
Apparent power S***	Excluding clamps	0.000 k ÷ 999.9 M	4 digits	±0.5 % · S
	With A 1227 Flex clamps	0.000 k ÷ 999.9k		±1.8 % · S
	With A 1281 Multirange clamps 100 A	0.000 k ÷ 999.9k		±0.8 % · S
	With A 1033 1000 A	000.0 k ÷ 999.9 k		±1.6 % · S

*Accuracy values are valid if $\cos \varphi \geq 0.80$, $I \geq 10 \% I_{Nom}$ and $U \geq 80 \% U_{Nom}$

**Accuracy values are valid if $\sin \varphi \geq 0.50$, $I \geq 10 \% I_{Nom}$ and $U \geq 80 \% U_{Nom}$

***Accuracy values are valid if $\cos \varphi \geq 0.50$, $I \geq 10 \% I_{Nom}$ and $U \geq 80 \% U_{Nom}$

6.2.8 Power factor (Pf)

Measuring range	Resolution	Accuracy
-1.00 ÷ 1.00	0.01	± 0.02

6.2.9 Displacement factor (Cos φ)

Measuring range	Resolution	Accuracy
0.00 ÷ 1.00	0.01	± 0.02

6.2.10 Energy

		Measuring range (kWh, kVAh, kVAh)	Resolution	Accuracy
Active energy eP*	Excluding clamps	000,000,000.001 ÷ 999,999,999.999	12 digits	±0.5 % · eP
	With A 1227 Flex clamps	000,000,000.001 ÷ 999,999,999.999		±1.8 % · eP

	With A 1281 Multirange clamps 100	000,000,000.001 ÷ 999,999,999.999		±0.8 % · eP
	With A 1033 1000 A	000,000,000.001 ÷ 999,999,999.999		±1.6 % · eP
Reactive energy eQ**	Excluding clamps	000,000,000.001 ÷ 999,999,999.999	12 digits	±0.5 % · eQ
	With A 1227 Flex clamps	000,000,000.001 ÷ 999,999,999.999		±1.8 % · eQ
	With A 1281 Multirange clamps 100	000,000,000.001 ÷ 999,999,999.999		±0.8 % · eP
	With A 1033 1000 A	000,000,000.001 ÷ 999,999,999.999		±1.6 % · eQ
Apparent energy eS***	Excluding clamps	000,000,000.001 ÷ 999,999,999.999	12 digits	±0.5 % · eS
	With A 1227 Flex clamps	000,000,000.001 ÷ 999,999,999.999		±1.8 % · eS
	With A 1281 Multirange clamps 100	000,000,000.001 ÷ 999,999,999.999		±0.8 % · eP
	With A 1033 1000 A	000,000,000.001 ÷ 999,999,999.999		±1.6 % · eS

*Accuracy values are valid if $\cos \varphi \geq 0.80$, $I \geq 10 \% I_{Nom}$ and $U \geq 80 \% U_{Nom}$

**Accuracy values are valid if $\sin \varphi \geq 0.50$, $I \geq 10 \% I_{Nom}$ and $U \geq 80 \% U_{Nom}$

***Accuracy values are valid if $\cos \varphi \geq 0.50$, $I \geq 10 \% I_{Nom}$ and $U \geq 80 \% U_{Nom}$

6.2.11 Voltage harmonics and THD

Measuring range	Resolution	Accuracy
$U_{hN} < 1 \% U_{Nom}$	10 mV	± 0.15 % · U_{Nom}
$1 \% U_{Nom} < U_{hN} < 20 \% U_{Nom}$	10 mV	± 5 % · U_{hN}

U_{Nom} : nominal voltage (RMS)

U_{hN} : measured harmonic voltage

N: harmonic component 1st ÷ 50th

Measuring range	Resolution	Accuracy
$0 \% U_{Nom} < THD_U < 20 \% U_{Nom}$	0.1 %	± 0.3

U_{Nom} : nominal voltage (RMS)

6.2.12 Current harmonics and THD

Measuring range	Resolution	Accuracy
$I_{hN} < 10 \% I_{Nom}$	10 mV	± 0.15 % · I_{Nom}
$10 \% I_{Nom} < I_{hN} < 100 \%$	10 mV	± 5 % · I_{hN}

I_{Nom} : Nominal current (RMS)

I_{hN} : measured harmonic current

N: harmonic component 1st ÷ 50th

Measuring range	Resolution	Accuracy
$0 \% I_{Nom} < THD_I < 100 \% I_{Nom}$	0.1 %	± 0.6
$100 \% I_{Nom} < THD_I < 200 \% I_{Nom}$	0.1 %	± 1.5

I_{Nom} : Nominal current (RMS)

6.2.13 Voltage interharmonics

Measuring range	Resolution	Accuracy
$U_{ihN} < 1 \% U_{Nom}$	10 mV	$\pm 0.15 \% \cdot U_{Nom}$
$1 \% U_{Nom} < U_{ihN} < 20 \% U_{Nom}$	10 mV	$\pm 5 \% \cdot U_{ihN}$

U_{Nom} : nominal voltage (RMS)

U_{ihN} : measured harmonic voltage

N : interharmonic component 1st ÷ 50th

6.2.14 Current interharmonics

Measuring range	Resolution	Accuracy
$I_{hN} < 10 \% I_{Nom}$	10 mV	$\pm 0.15 \% \cdot I_{Nom}$
$10 \% I_{Nom} < I_{hN} < 100 \% I_{Nom}$	10 mV	$\pm 5 \% \cdot I_{ihN}$

I_{Nom} : Nominal current (RMS)

I_{hN} : measured interharmonic current

N : interharmonic component 1st ÷ 50th

6.2.15 Signalling

Measuring range	Resolution	Accuracy
$1 \% U_{Nom} < U_{Sig} < 3 \% U_{Nom}$	10 mV	$\pm 0.15 \% \cdot U_{Nom}$
$3 \% U_{Nom} < U_{Sig} < 20 \% U_{Nom}$	10 mV	$\pm 5 \% \cdot U_{Sig}$

U_{Nom} : Nominal current (RMS)

U_{Sig} : Measured signalling voltage

6.2.16 Unbalance

	Unbalance range	Resolution	Accuracy
$\frac{u^-}{u^0}$	0.5 % ÷ 5.0 %	0.1 %	$\pm 0.15 \% \cdot u^{-(0)}$
$\frac{i^-}{i^0}$			
$\frac{i^-}{i^0}$	0.0 % ÷ 17 %	0.1 %	$\pm 1 \% \cdot i^{-(0)}$

6.2.17 Time and duration uncertainty

Real time clock (RTC) uncertainty

Operating range	Accuracy	
-20 °C ÷ 70 °C	± 3.5 ppm	0.3 s/day
0 °C ÷ 40 °C	± 2.0 ppm	0.17 s/day

Event duration and recorder time-stamp and uncertainty

	Measuring Range	Resolution	Error
Event Duration	30 ms ÷ 7 days	1 ms	± 1 cycle

6.2.18 Temperature

Measuring range	Resolution	Accuracy
-10.0 °C ÷ 85.0 °C	0.1 °C	± 0.5°C
-20.0 °C ÷ -10.0 °C and 85.0 °C ÷ 125.0 °C		± 2.0°C

6.3 Recorders

6.3.1 General recorder

Sampling	5 readings per second, continuous sampling per channel. All channels are sampled simultaneously. Sampling frequency is continuously synchronized with main frequency.					
Recording time	From 30 min with 1 second display resolution up to 99 days with 1 hour display resolution.					
Recording type	Linear – start and stop in accordance to user settings. Circular – when recorded data exceeds free memory, oldest data in the current recording are overwritten with the new one.					
Recording quantities	1 ÷ 524 parameters can be recorded. For each parameter minimum, maximal average and active average value is stored. For default recorder settings (179 signals selected for recording)					
Resolution	1 s	3 s	5 s	10 s	1 min	2 min
Duration	1 hr	4 hrs	7 hrs	15 hrs	3 days	7 days
Resolution	5 min	10 min	15 min	30 min	60 min	
Duration	18 days	37 days	56 days	99 days	99 days	
Events	Up to 1000 voltage events signatures can be stored into record					
Alarms	Up to 1000 alarms signatures can be stored into record					
Trigger	Start time or manual					

6.3.2 Waveform recorder

Sampling	102.4 samples per cycle period, continuous sampling per channel. All channels are sampled simultaneously. Sampling frequency is continuously synchronized with mains frequency.					
Recording time	From 10 cycle period to 3770 cycle periods					
Recording type	Single – waveform recording ends after first trigger. Continuous – consecutive waveform recording until user stops the measurement or instrument runs out of storage memory.					
Recording quantities	Waveform samples of: $U_1, U_2, U_3, U_N, (U_{12}, U_{23}, U_{31}), I_1, I_2, I_3, I_N$					
	For 50 Hz mains frequency					
No. of signals	1	2	4	8		
Duration	75 sec	38 sec	19 sec	9 sec		
Trigger:	Voltage event, alarms defined in alarm table or manual					

6.3.3 Inrush/fast recorder

Sampling	1 reading per half-cycle ÷ 1 reading per 10-cycles (for 50 Hz mains frequency: 5 to 100 readings per second) All channels are sampled simultaneously. Sampling frequency is continuously synchronized with mains frequency.					
Recording time	From 1 s ÷ 3 min					
Recording type	Single – inrush recording ends after first trigger Continuous – consecutive inrush recording until user stops the measurement or instrument runs out of storage memory.					
Recording	$U_{1Rms(1/2)}, U_{2Rms(1/2)}, U_{3Rms(1/2)}, U_{NRms(1/2)}, (U_{12Rms(1/2)}, U_{23Rms(1/2)},$					

quantities	$U_{31Rms(1/2)}, I_{1\frac{1}{2}Rms}, I_{2\frac{1}{2}Rms}, I_{3\frac{1}{2}Rms}, I_{N\frac{1}{2}Rms}$			
	For 50 Hz mains frequency			
No. of signals	1	2	4	8
Duration	686 s	514 s	343 s	205 s
Trigger	Percent of nominal voltage or current range (rise, fall or both edges)			

6.3.4 Waveform snapshot

Sampling	102.4 samples per cycle. All channels are sampled simultaneously.			
Recording time	10 cycle period			
Recording quantities	Waveform samples of: $U_1, U_2, U_3, U_N, (U_{12}, U_{23}, U_{31}), I_1, I_2, I_3, I_N$ Signatures are calculated from samples afterwards.			
Trigger:	Manual			

6.3.5 Transients recorder

Sampling	1024 samples per cycle. All channels are sampled simultaneously.			
Recording time	From 1 ÷ 47 cycle period			
Recording quantities	Waveform samples of: $U_1, U_2, U_3, U_N, (U_{12}, U_{23}, U_{31}), I_1, I_2, I_3, I_N$ Calculated for all channels: $U_{RMS}, I_{RMS}, THD_U, THD_I$			
Trigger:	Manual, dV - for detail see section 5.1.17			

6.4 Standards compliance

6.4.1 Compliance to the to the IEC 61000-4-30

IEC 61000-4-30 Section and Parameter	PowerQ4 Plus Parameter	Class
4.4 Aggregation of measurements in time intervals		A
4.6 Real time clock (RTC) uncertainty		A
5.1 Frequency	freq	A
5.2 Magnitude of the Supply <ul style="list-style-type: none"> Line to neutral voltage magnitude Line to line voltage magnitude 	$U_1, U_2, U_3, U_N,$ U_{12}, U_{23}, U_{31}	A S
5.3 Flicker*	P_{st}	A
5.4 Dips and Swells	U_{Dip}, U_{Swell} duration	A
5.5 Interruptions	U_{Int} duration	A
5.7 Unbalance	u^-, u^0	A
5.8 Voltage Harmonics	U_{hN}	A
5.9 Voltage Interharmonics	U_{ihN}	A
5.10 Mains signalling voltage	U_{Sig}	A

* For limitations in section 6.2.6

6.4.2 Compliance to the IEC 61557-12

General and essential characteristic

Power quality assessment function	-S
Classification according to 4.3	SD Indirect current and direct voltage measurement
	SS Indirect current and indirect voltage measurement
Temperature	K50
Humidity + altitude	Standard

Measurement characteristic

Measured parameter	Class according to IEC 61557-12	Measuring range
P	1	5 % ÷ 200% $I_{Nom}^{(1)}$
Q	1	5 % ÷ 200% $I_{Nom}^{(1)}$
S	1	5 % ÷ 200% $I_{Nom}^{(1)}$
eP	1	5 % ÷ 200% $I_{Nom}^{(1)}$
eQ	2	5 % ÷ 200% $I_{Nom}^{(1)}$
eS	1	5 % ÷ 200% $I_{Nom}^{(1)}$
PF	0.5	- 1 ÷ 1
f	0.02	10 Hz ÷ 70 Hz
I, I_{Nom}	0.5	5 % I_{Nom} ÷ 200 % I_{Nom}
U	0.2	20 V ÷ 1000 V
P_{st}, P_{It}	5	0.4 ÷ 4
U_{dip}, U_{swl}	1	5 V ÷ 1500 V
U_{int}	0.5	0 V ÷ 100 V
u^-, u^0	0.2	0.5 % ÷ 17 %
U_{h_n}	1	0 % ÷ 20 % U_{Nom}
THD_u	1	0 % ÷ 20 % U_{Nom}
I_{h_n}	1	0 % ÷ 100 % I_{Nom}
THD_i	2	0 % ÷ 100 % I_{Nom}

(1) - Measurement range depends on current sensor. According to the IEC 61557-12, if current sensor has I_{Nom} defined as $I_{Nom} = k \cdot A/V$, then measurement range is: 2 % I_{Nom} ÷ 200 % I_{Nom} .

7 Maintenance

7.1 Inserting batteries into the instrument

1. Make sure that the power supply adapter/charger and measurement leads are disconnected and the instrument is switched off.
2. Insert batteries as shown in figure bellow (insert batteries correctly, otherwise the instrument will not operate and the batteries could be discharged or damaged).

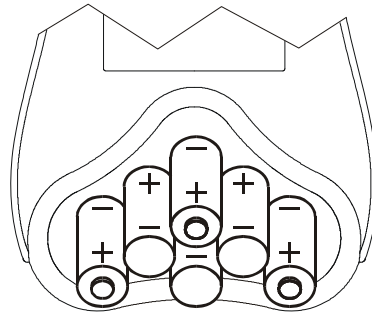

Figure 7.1: Battery placement

3. Turn the display side of the instrument lower than the battery holder (see figure below) and put the cover on the batteries.

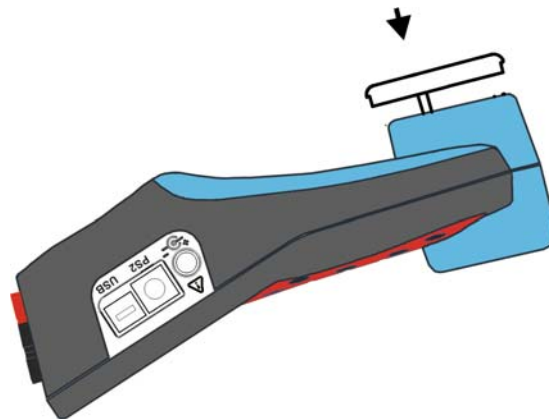

Figure 7.2: Closing the battery holder

4. Screw the cover on the instrument.
If the instrument is not going to be used for a long period of time remove all batteries from the battery holder. The enclosed batteries can supply the instrument for approx. 15 hours.

Warnings!

- When battery cells have to be replaced, turn off the instrument before opening battery compartment cover.
- Hazardous voltages exist inside the instrument. Disconnect all test leads and remove the power supply cable before removing battery compartment cover.
- Use only power supply adapter/charger delivered from manufacturer or distributor of the equipment to avoid possible fire or electric shock.
- Rechargeable NiMh batteries type HR 6 (size AA) are recommended. The charging time and the operating hours are given for batteries with a nominal capacity of 2500 mAh.
- Do not use standard batteries while power supply adapter/charger is connected, otherwise they may explode!
- Do not mix batteries of different types, brands, ages, or charge levels.
- When charging batteries for the first time, make sure to charge batteries for at least 24 hours before switching on the instrument.

7.2 Batteries

Instrument contains rechargeable NiMh batteries. These batteries should only be replaced with the same type as defined on the battery placement label or in this manual. If it is necessary to replace batteries, all six have to be replaced. Ensure that the batteries are inserted with the correct polarity; incorrect polarity can damage the batteries and/or the instrument.

Precautions on charging new batteries or batteries unused for a longer period

Unpredictable chemical processes can occur during charging new batteries or batteries that were unused for a longer period of time (more than 3 months). NiMH and NiCd batteries are affected to a various degree (sometimes called as memory effect). As a result the instrument operation time can be significantly reduced at the initial charging/discharging cycles.

Therefore it is recommended:

- To completely charge the batteries
- To completely discharge the batteries (can be performed with normal working with the instrument).
- Repeating the charge/discharge cycle for at least two times (four cycles are recommended).

When using external intelligent battery chargers one complete discharging /charging cycle is performed automatically.

After performing this procedure a normal battery capacity is restored. The operation time of the instrument now meets the data in the technical specifications.

Notes

The charger in the instrument is a pack cell charger. This means that the batteries are connected in series during the charging so all batteries have to be in similar state (similarly charged, same type and age).

Even one deteriorated battery (or just of another type) can cause an improper charging of the entire battery pack (heating of the battery pack, significantly decreased operation time).

If no improvement is achieved after performing several charging/discharging cycles the state of individual batteries should be determined (by comparing battery voltages, checking them in a cell charger etc). It is very likely that only some of the batteries are deteriorated.

The effects described above should not be mixed with normal battery capacity decrease over time. All charging batteries lose some of their capacity when repeatedly charged/discharged. The actual decrease of capacity versus number of charging cycles depends on battery type and is provided in the technical specification of batteries provided by battery manufacturer.

7.3 Power supply considerations



Warnings

- **Use only charger supplied by manufacturer.**

- **Disconnect power supply adapter if you use standard (non-rechargeable) batteries.**

When using the original power supply adapter/charger the instrument is fully operational immediately after switching it on. The batteries are charged at the same time, nominal charging time is 4 hours.

The batteries are charged whenever the power supply adapter/charger is connected to the instrument. Inbuilt protection circuit controls the charging procedure and assure maximal battery lifetime.

If the instrument is left without batteries and charger for more than 2 minutes, time and date settings are reset.

7.4 Cleaning

To clean the surface of the instrument use a soft cloth slightly moistened with soapy water or alcohol. Then leave the instrument to dry totally before use.



Warnings

- **Do not use liquids based on petrol or hydrocarbons!**
- **Do not spill cleaning liquid over the instrument!**

7.5 Periodic calibration

To ensure correct measurement, it is essential that the instrument is regularly calibrated. If used continuously on a daily basis, a six-month calibration period is recommended, otherwise annual calibration is sufficient.

7.6 Service

For repairs under or out of warranty please contact your distributor for further information.

7.7 Troubleshooting

If *Esc* button is pressed when switching on the instrument, the instrument will not start. You have to remove batteries and put them back. After that the instrument starts normally.

Manufacturer address:

METREL d.d.
Ljubljanska 77,
SI-1354 Horjul,
Slovenia

Tel: +(386) 1 75 58 200
Fax: +(386) 1 75 49 095
Email: metrel@metrel.si
<http://www.metrel.si>

